



# Camry

Front & rear set mud flaps

Installation instructions

Model year: 2011/09  
Vehicle code: \*\*V5\*\*-\*E\*\*\*\*  
Part number: PZQ41-33030

Manual reference number: AIM 002 615-2

# Revision Record

Rev. No.	Date	Page	Picture	Update	New	Deleted
1	13.08.12	1		X		
1	13.08.12	8	11	X		
1	13.08.12	9	15	X		
2	07.12.12	1		X		

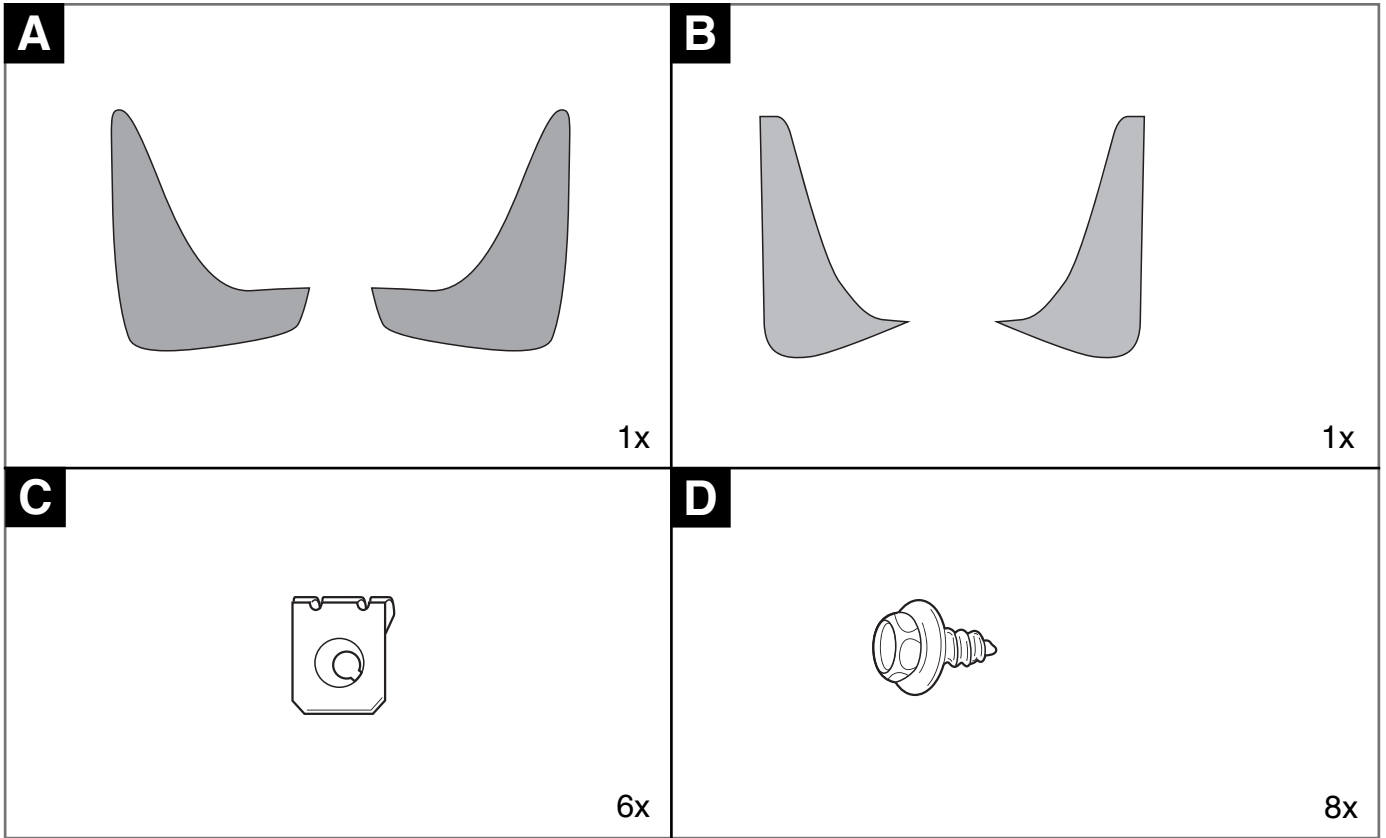

86705-YY030

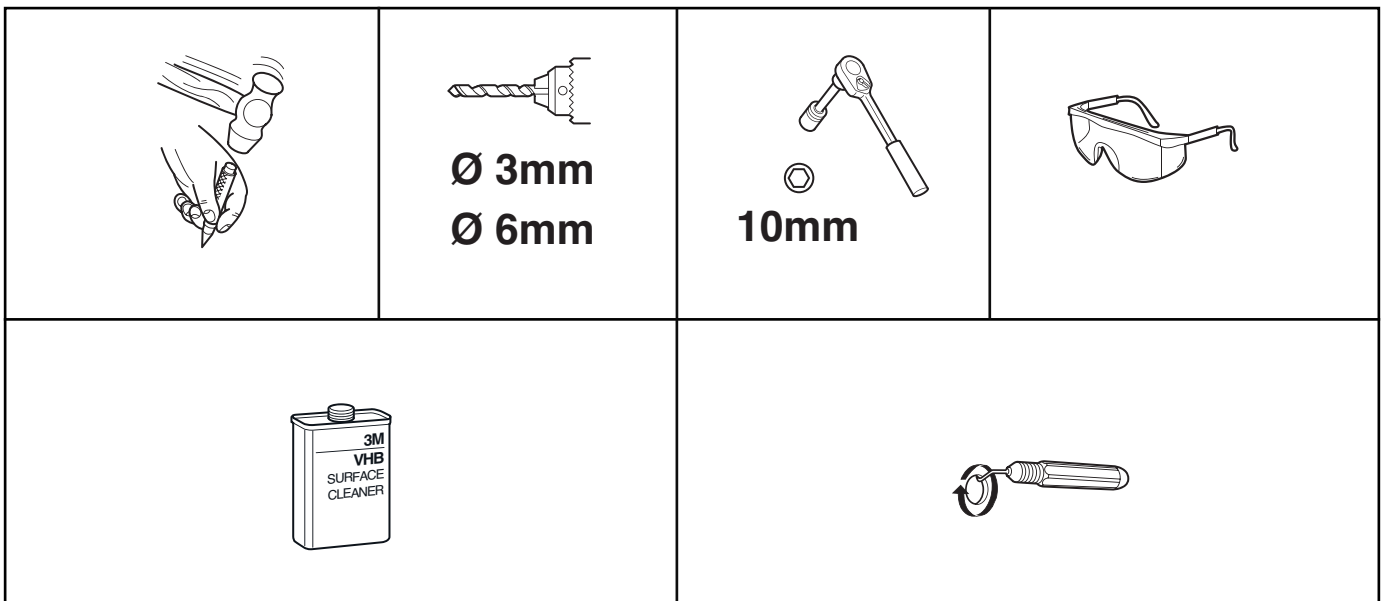

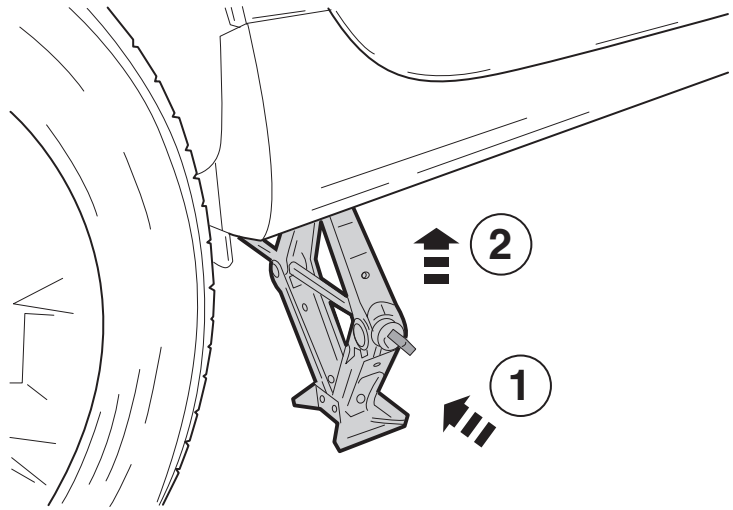
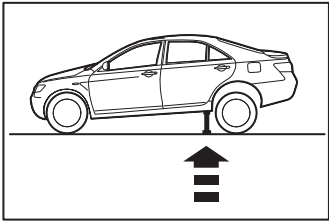

1

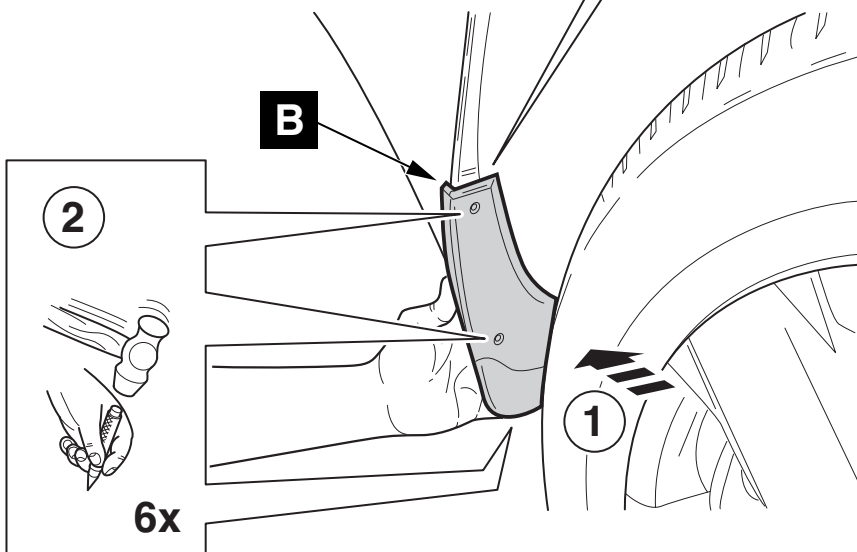
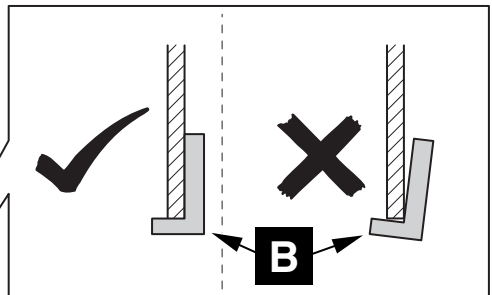
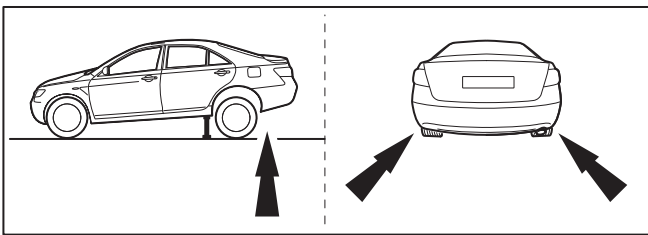

2

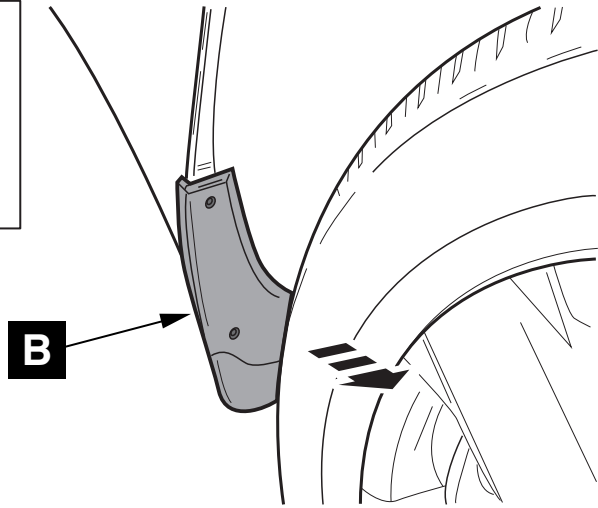
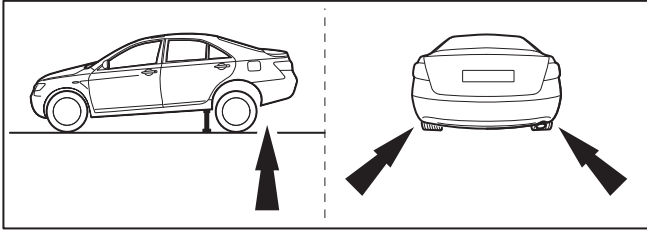

**3**

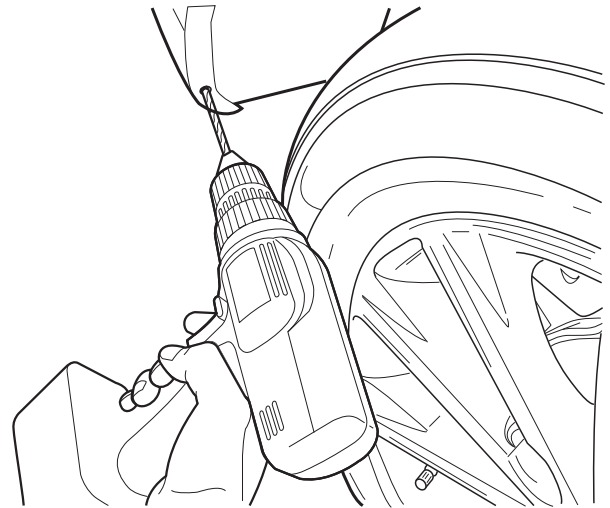
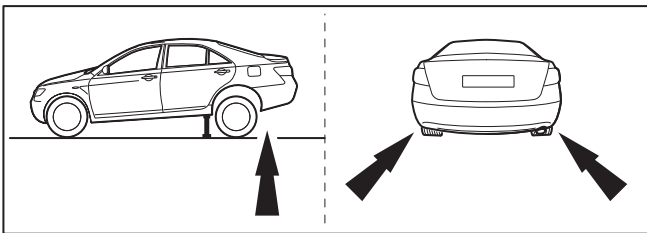

1

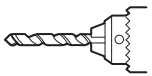

Ø 3mm

6x

2

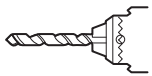

Ø 6mm

6x

3

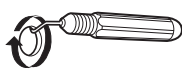

6x

**4**

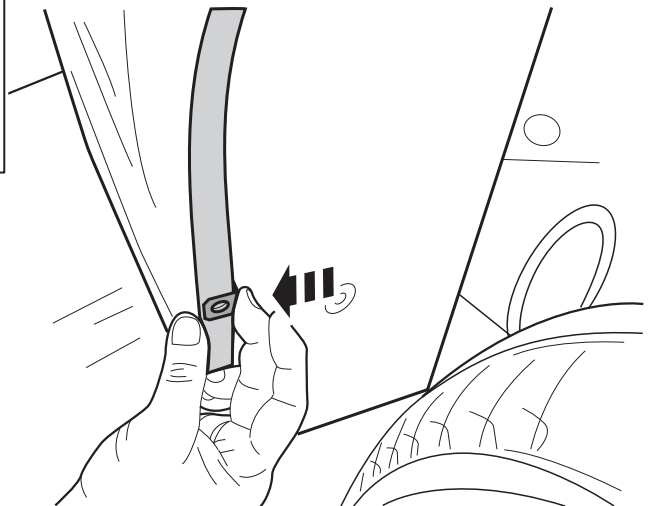
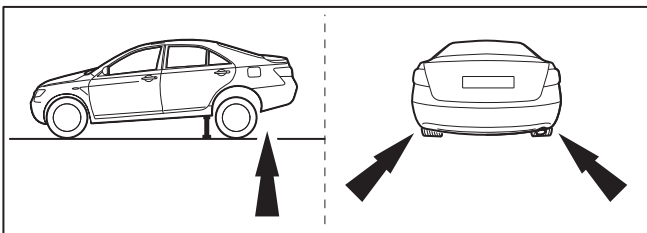

**C**



6x

**5**

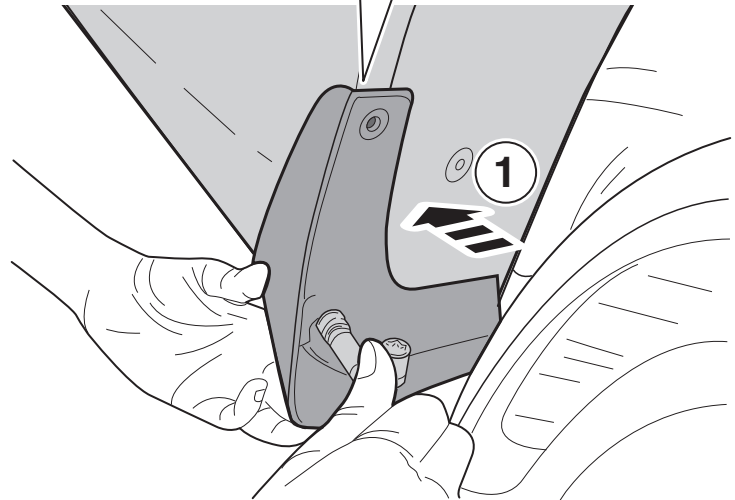
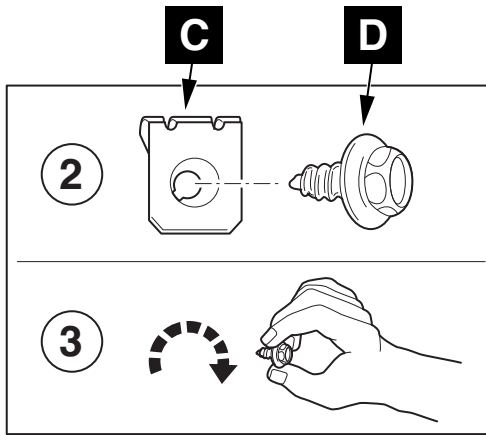
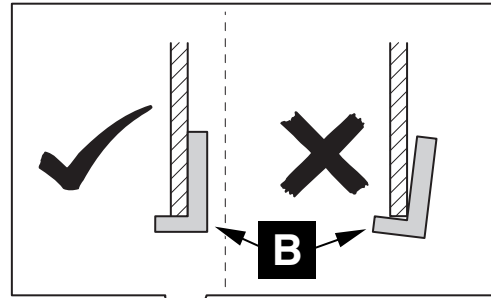
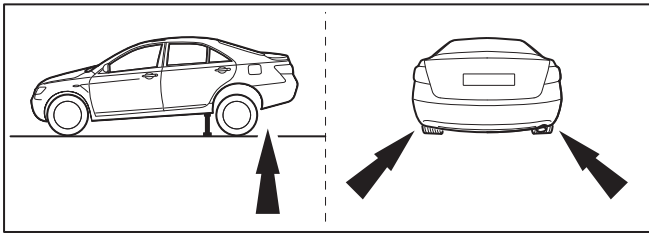

6

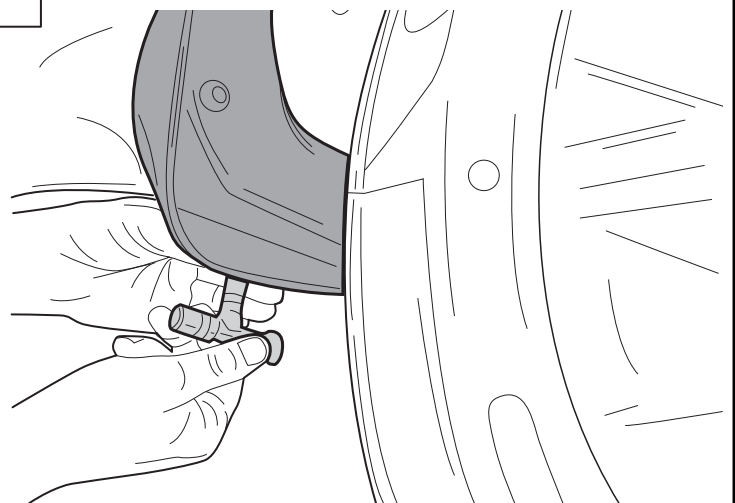
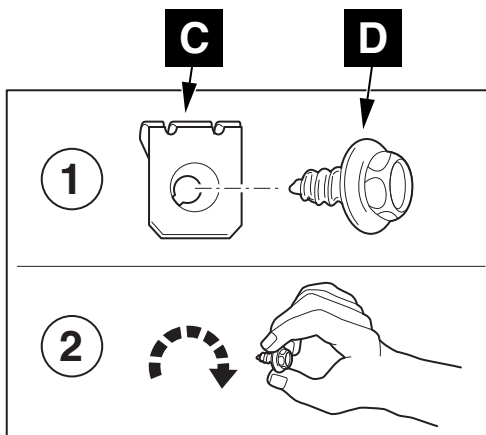
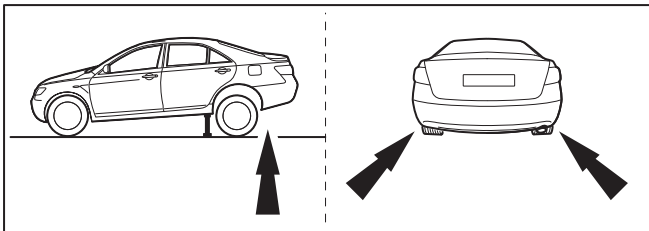

7

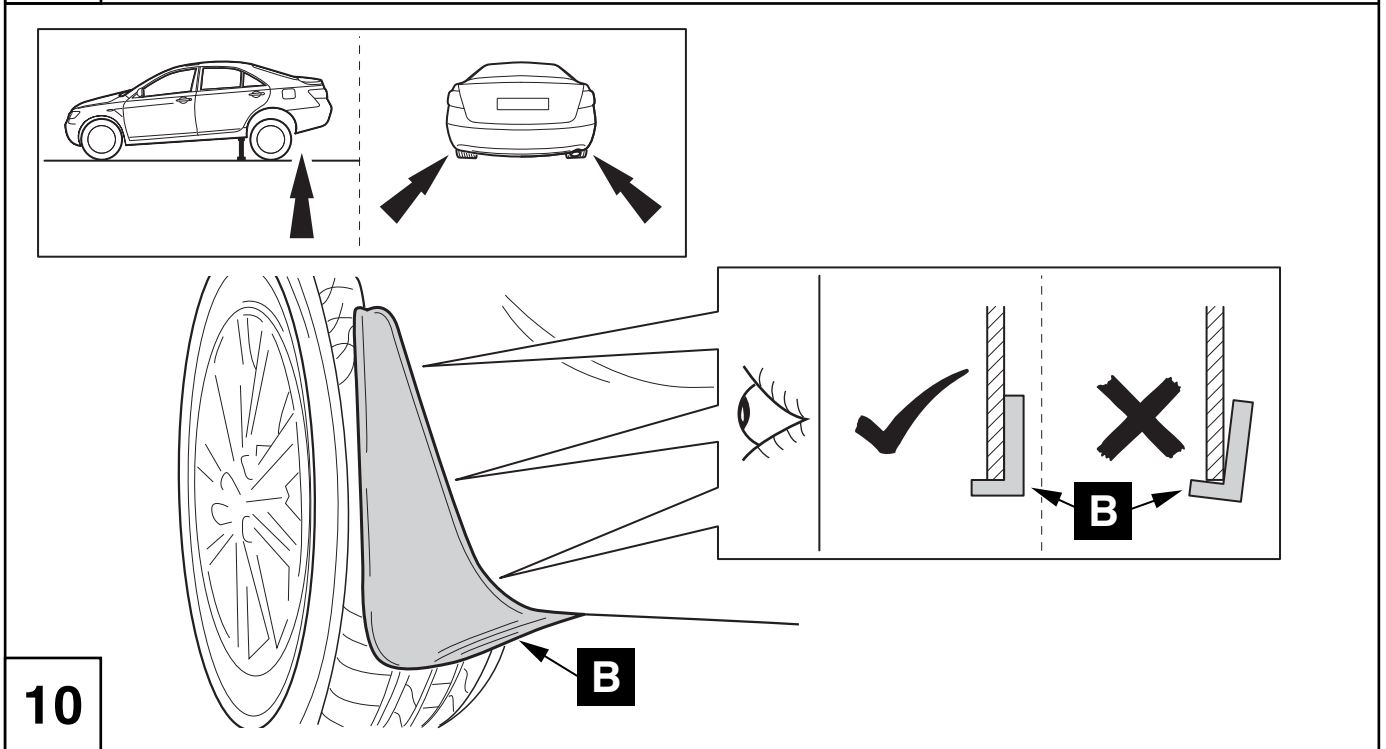
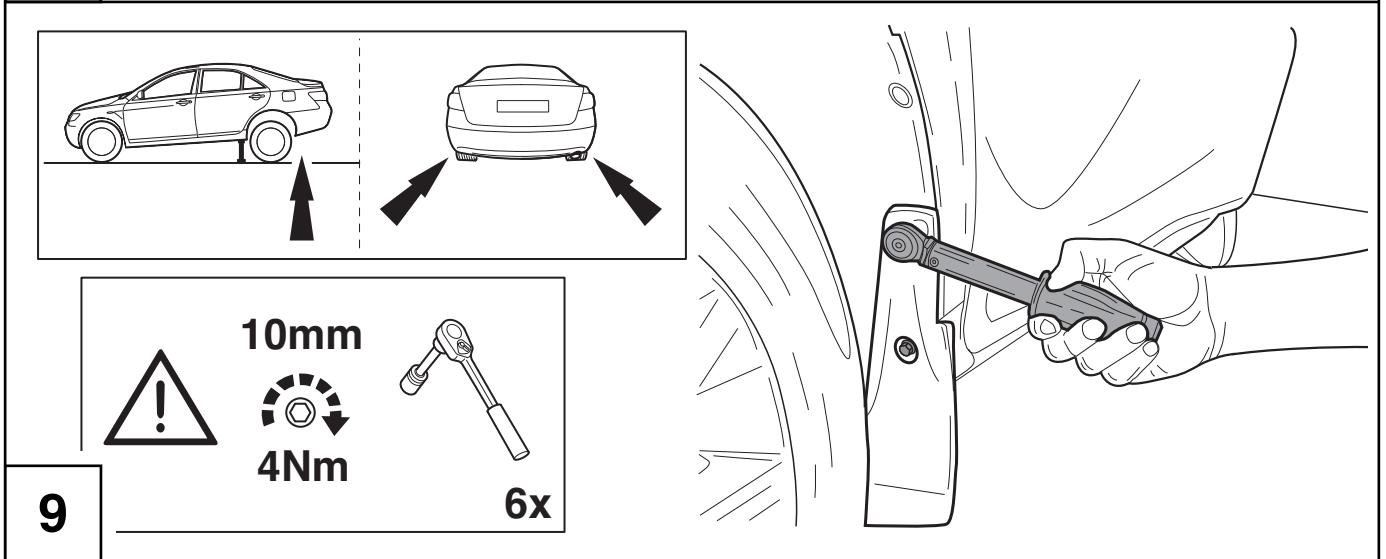
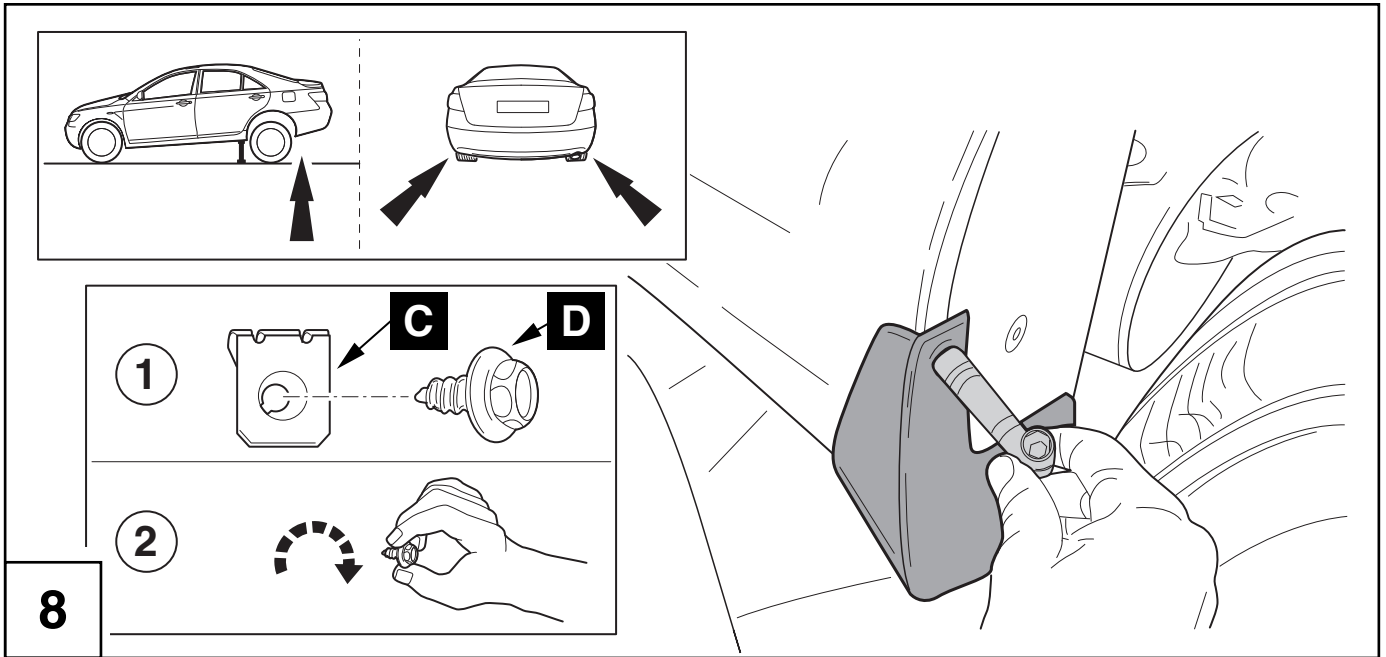

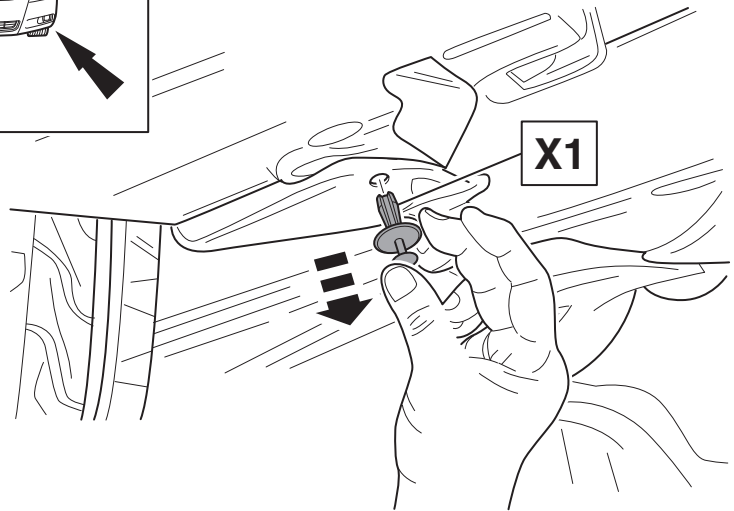
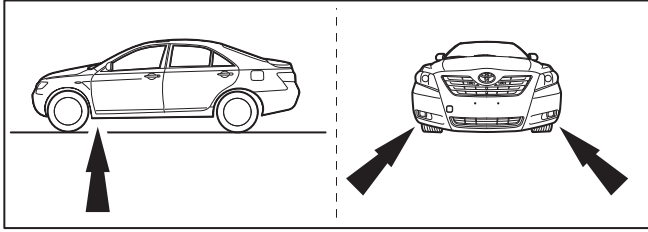

11

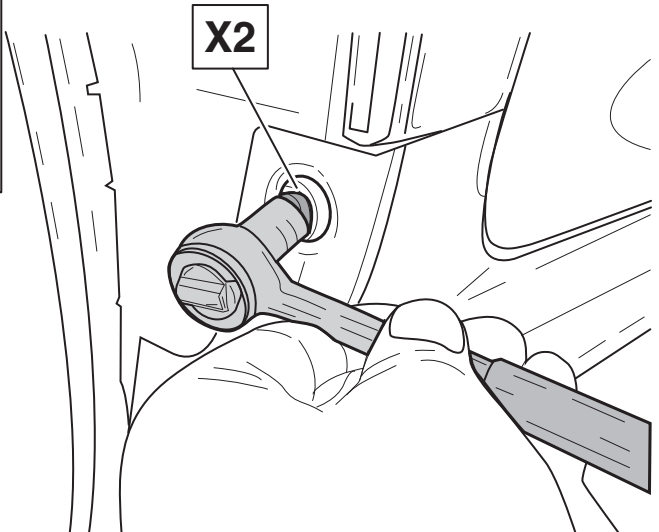
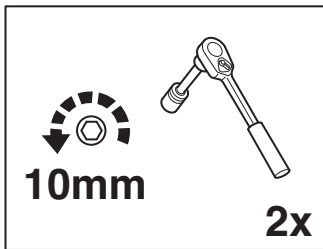
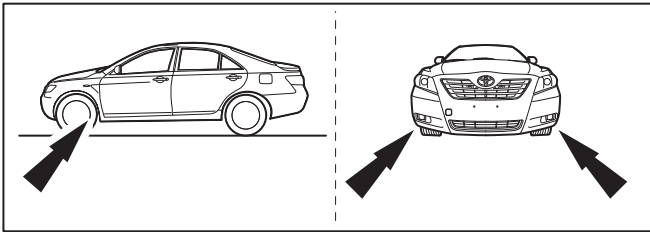

12

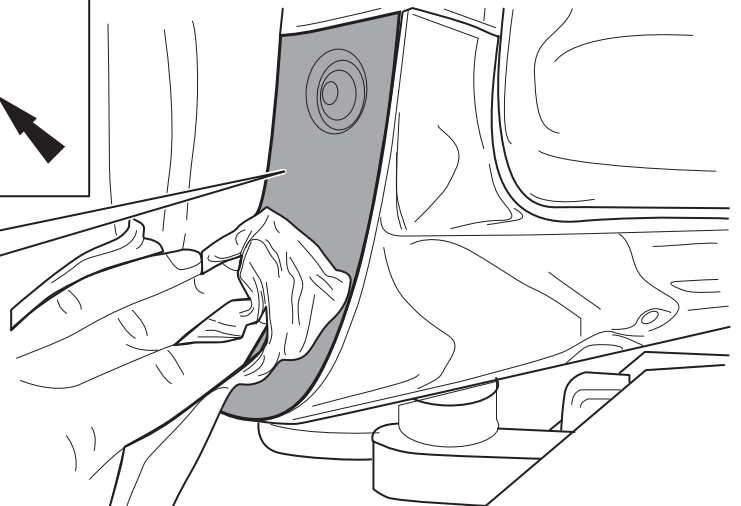
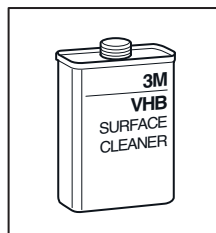
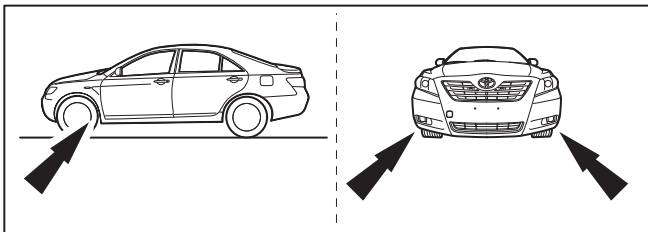

13



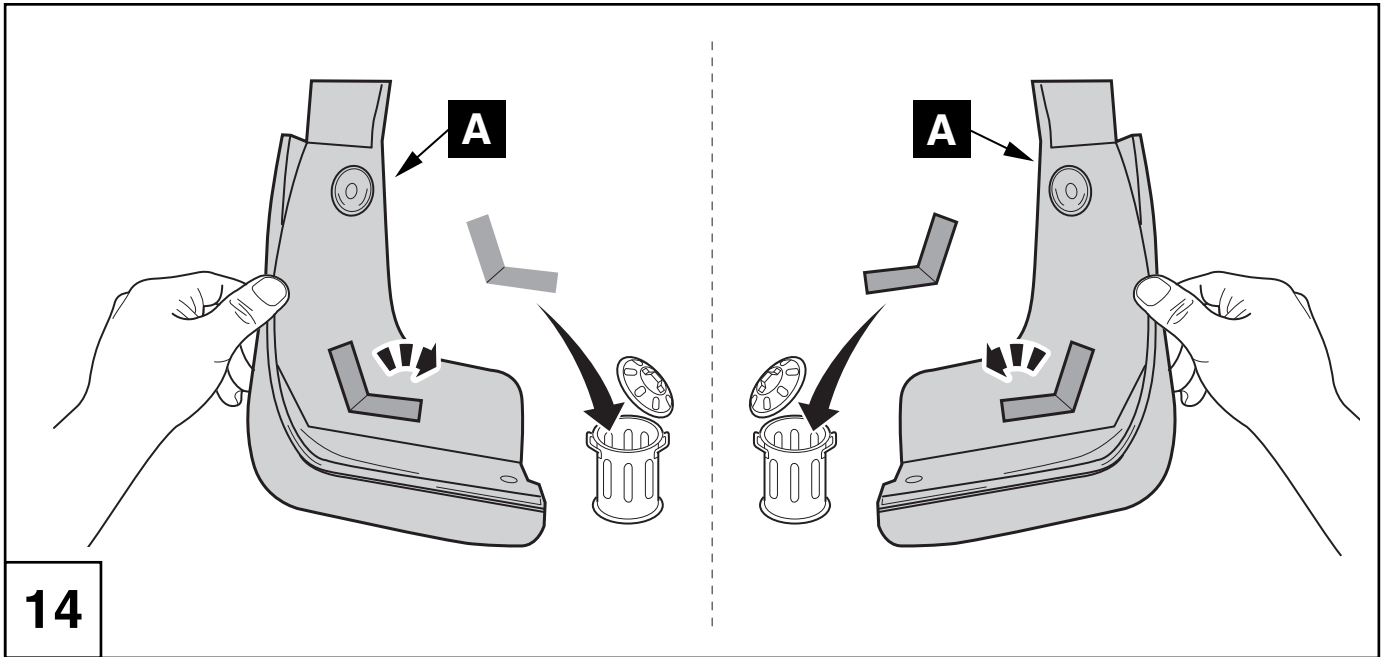

14

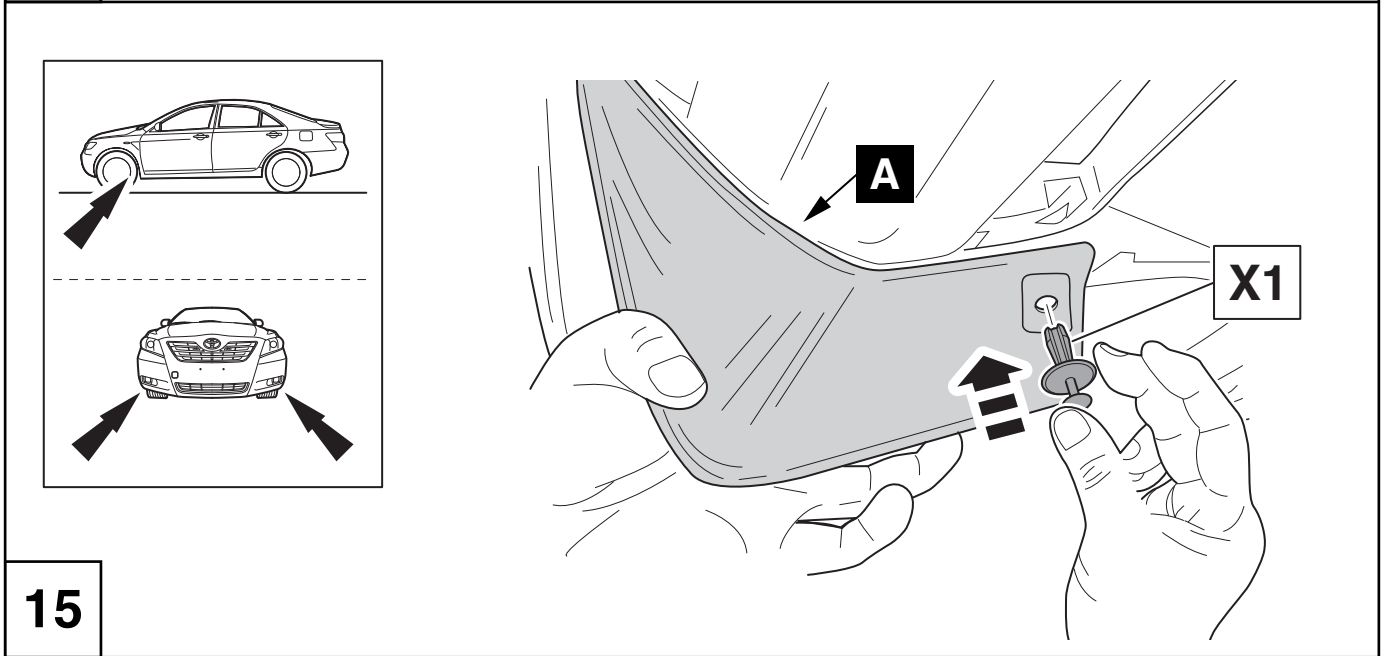

15

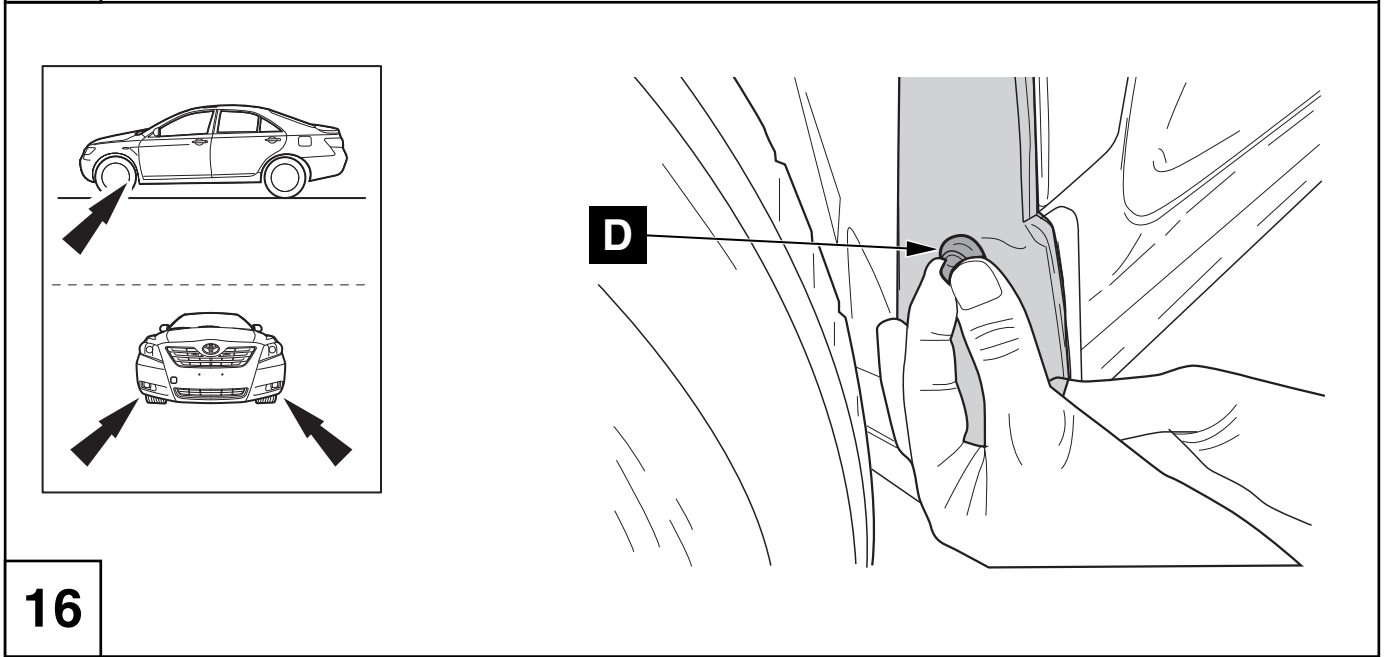

16

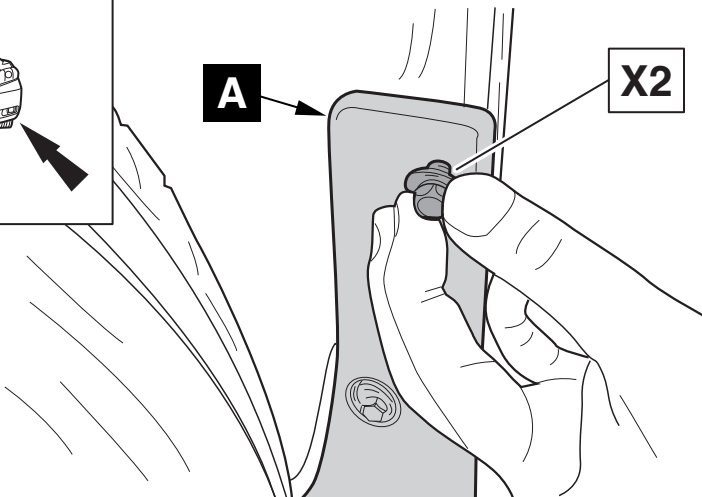
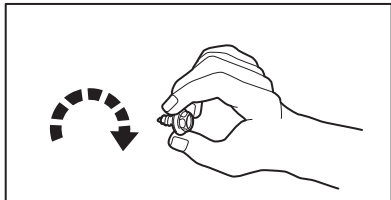
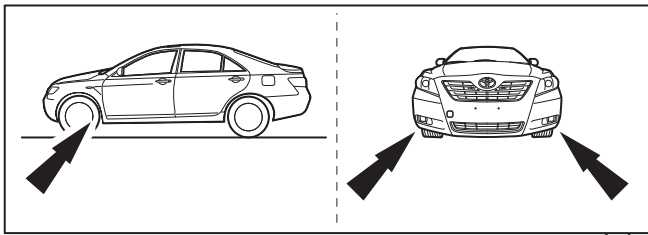

17

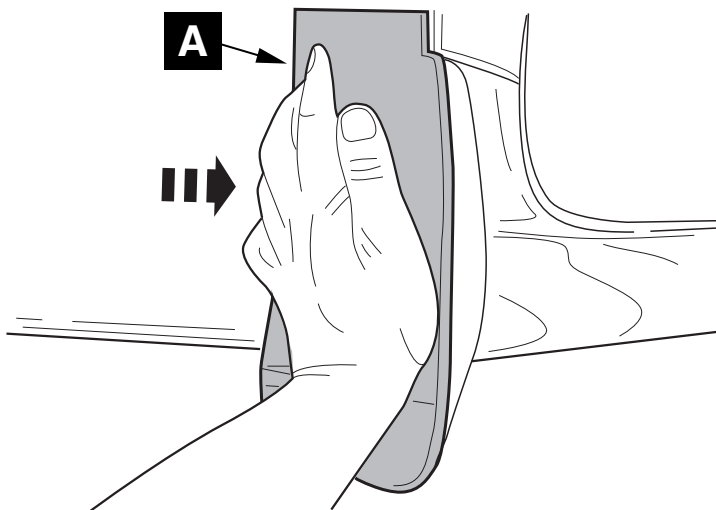
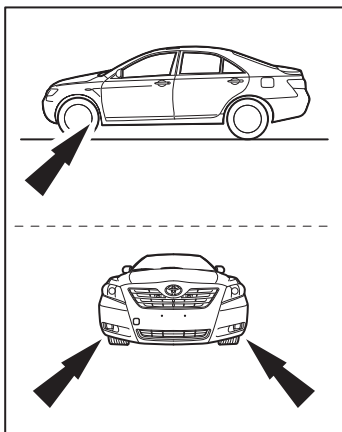

18

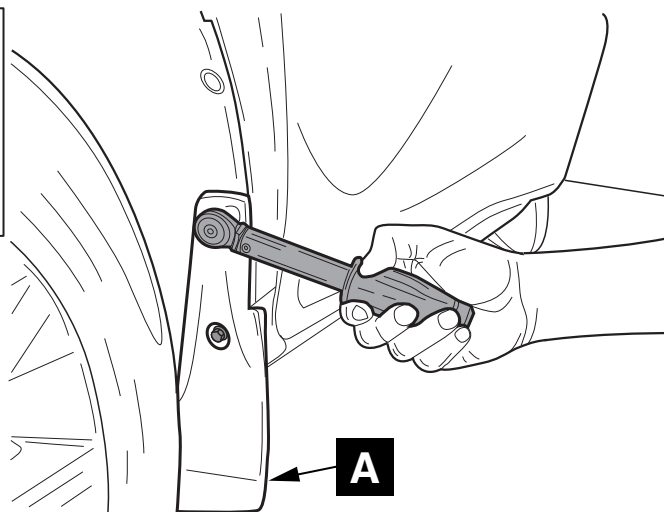
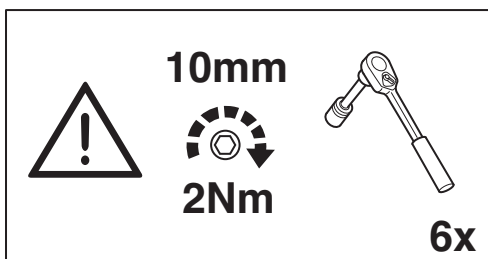
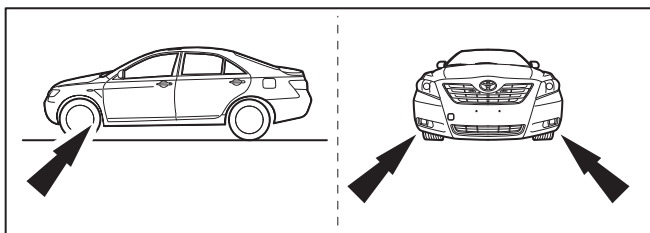

19

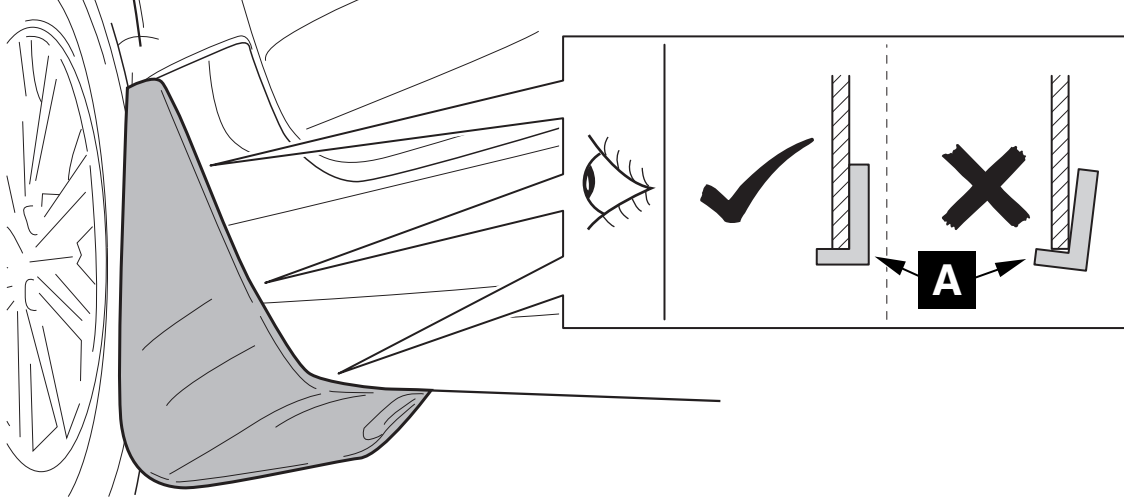
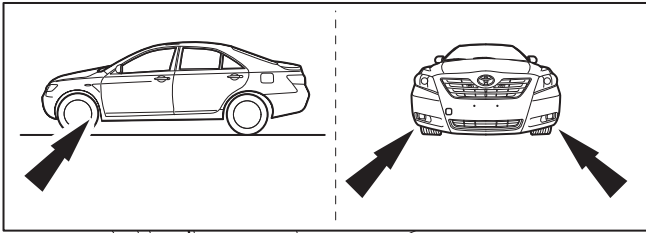

20