



TOYOTA

ALWAYS A
BETTER WAY

Yaris

Side sills

Installation Instruction

Model year: 2020/06
Vehicle code: **P*11-BH***W
Part number: PW156-0D100-**

Manual reference number: AIM 004 590 - 0

Revision Record

Rev. No.	Date	Page	Step	Remarks

PW156-0D100-**

PW156-0D101-**

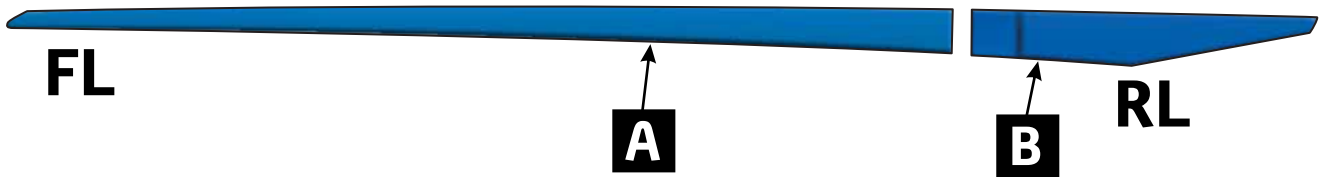

PW156-0D102-**

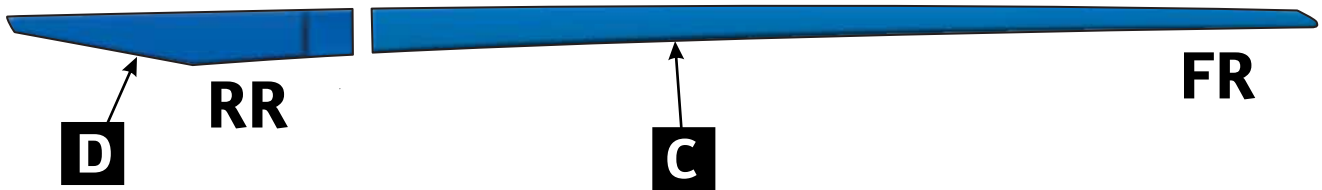

INFO



Material Safety Data Sheet

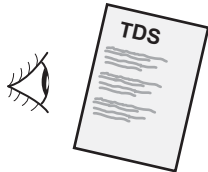
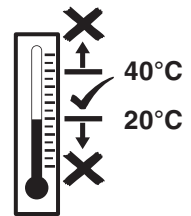

Technical Data Sheet

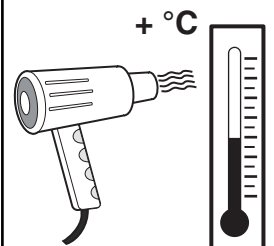
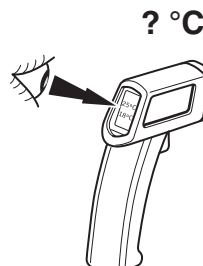
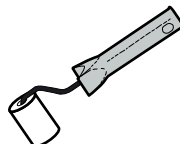
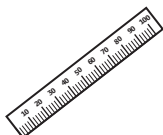
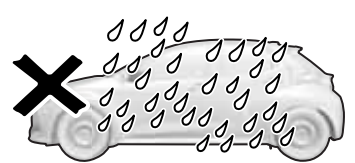
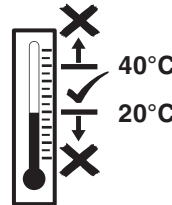
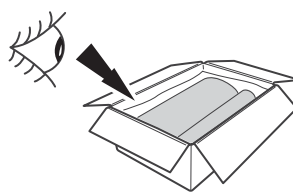

AIM 003-516-*

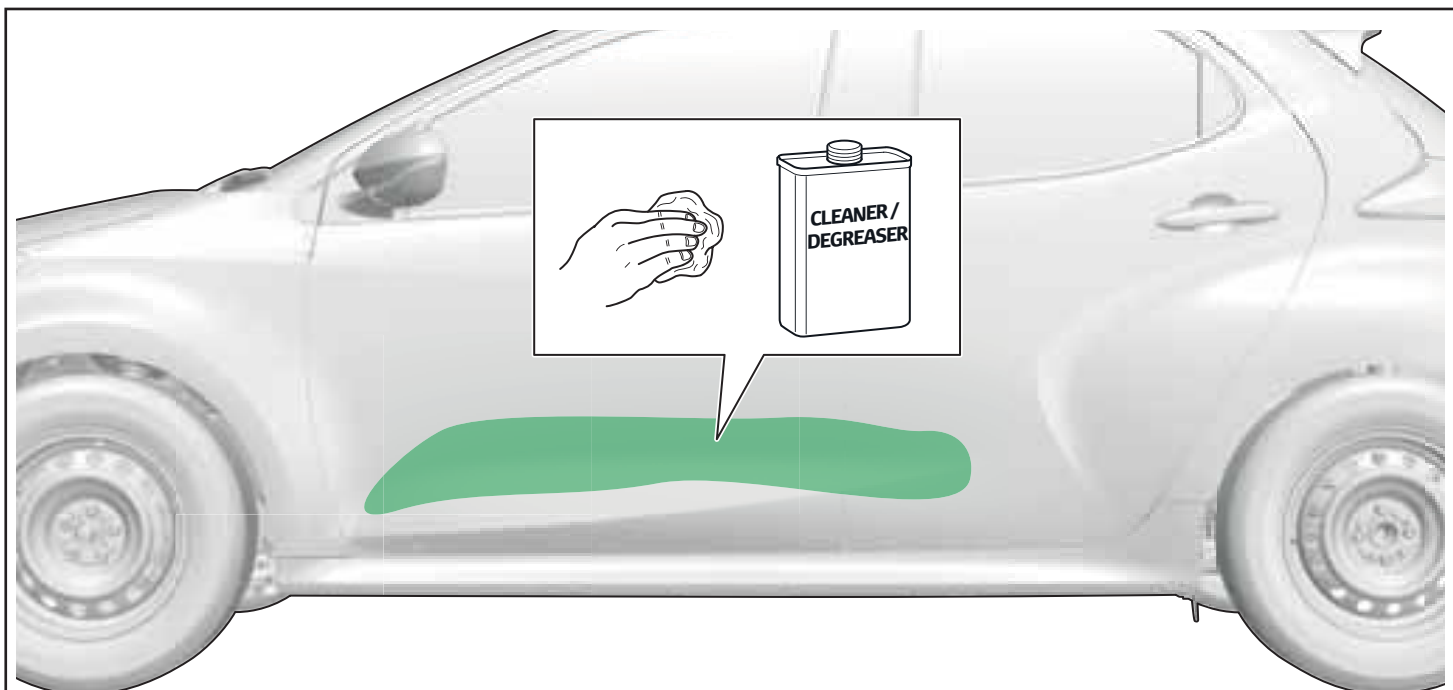

1

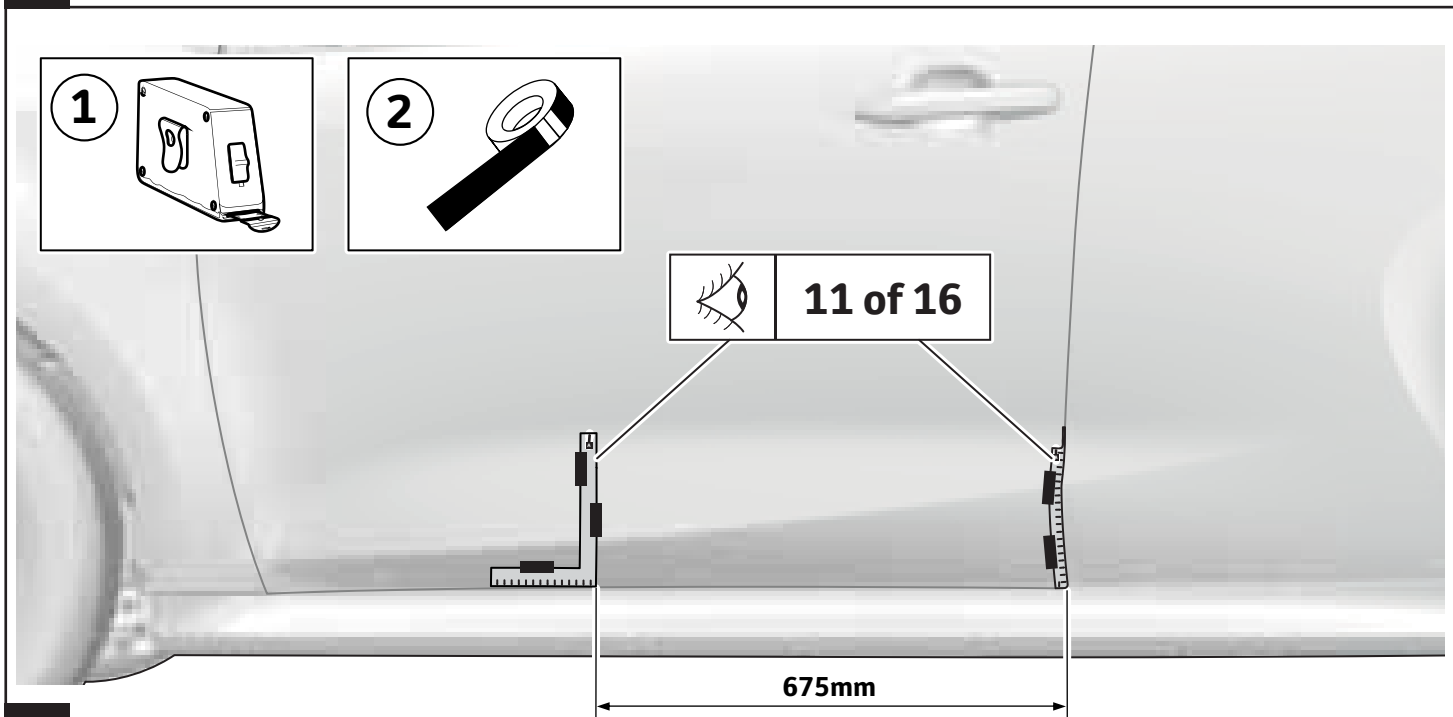

2

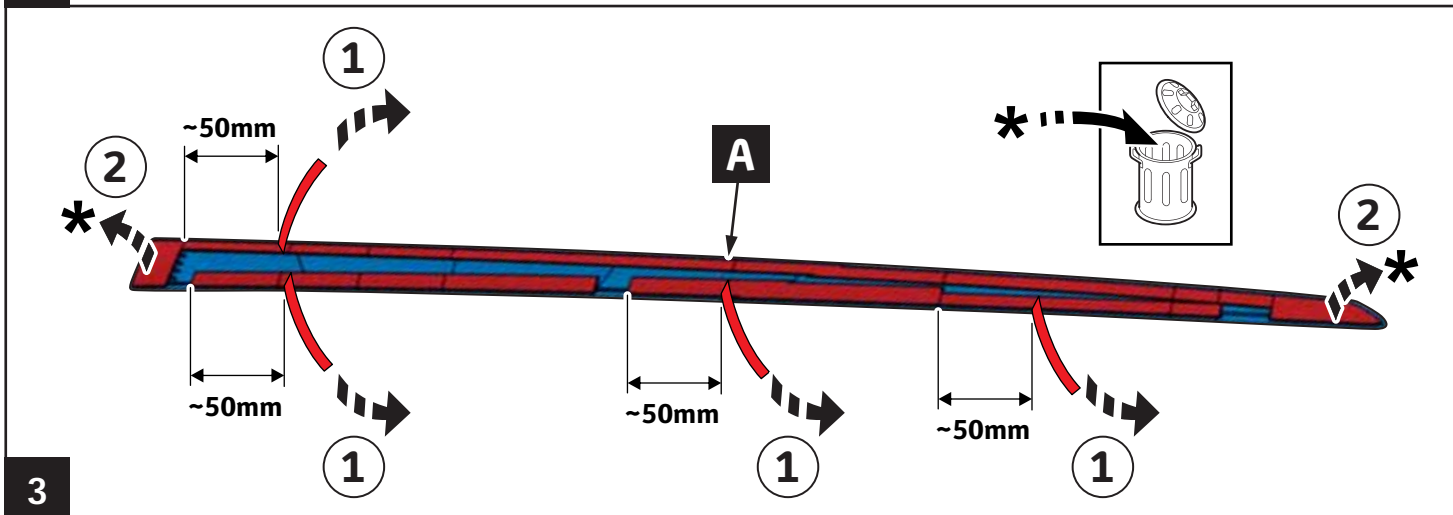

3

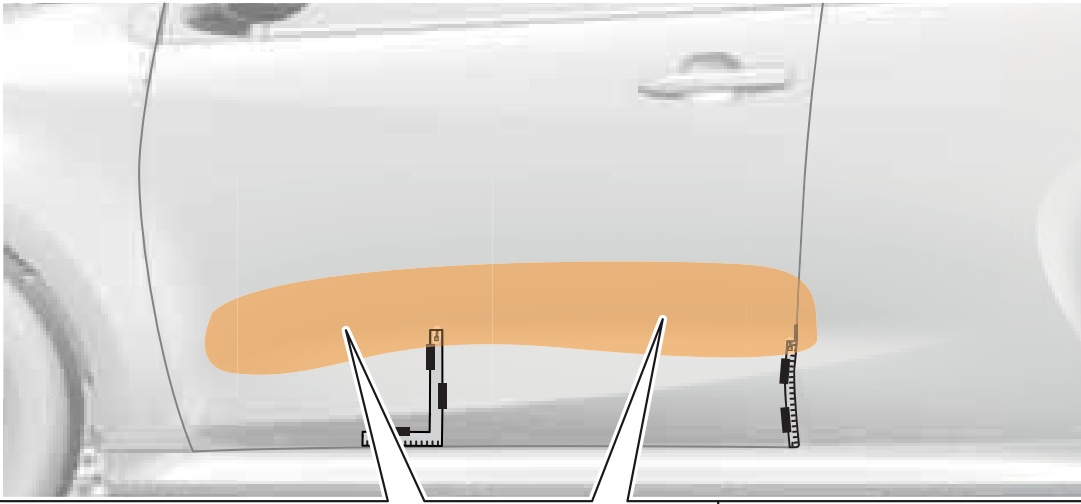

<p>1</p>	<p>< 20°C → 2</p> <p>> 20°C - 40°C → 5</p>	<p>2</p>
<p>3</p>	<p>> 20°C - 40°C → 5</p>	<p>INFO</p>

4

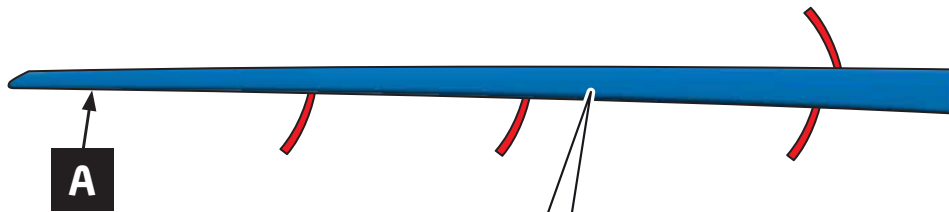

<p>1</p>	<p>< 20°C → 2</p> <p>> 20°C - 40°C → 6</p>	<p>2</p>
<p>3</p>	<p>> 20°C - 40°C → 6</p>	<p>INFO</p>

5

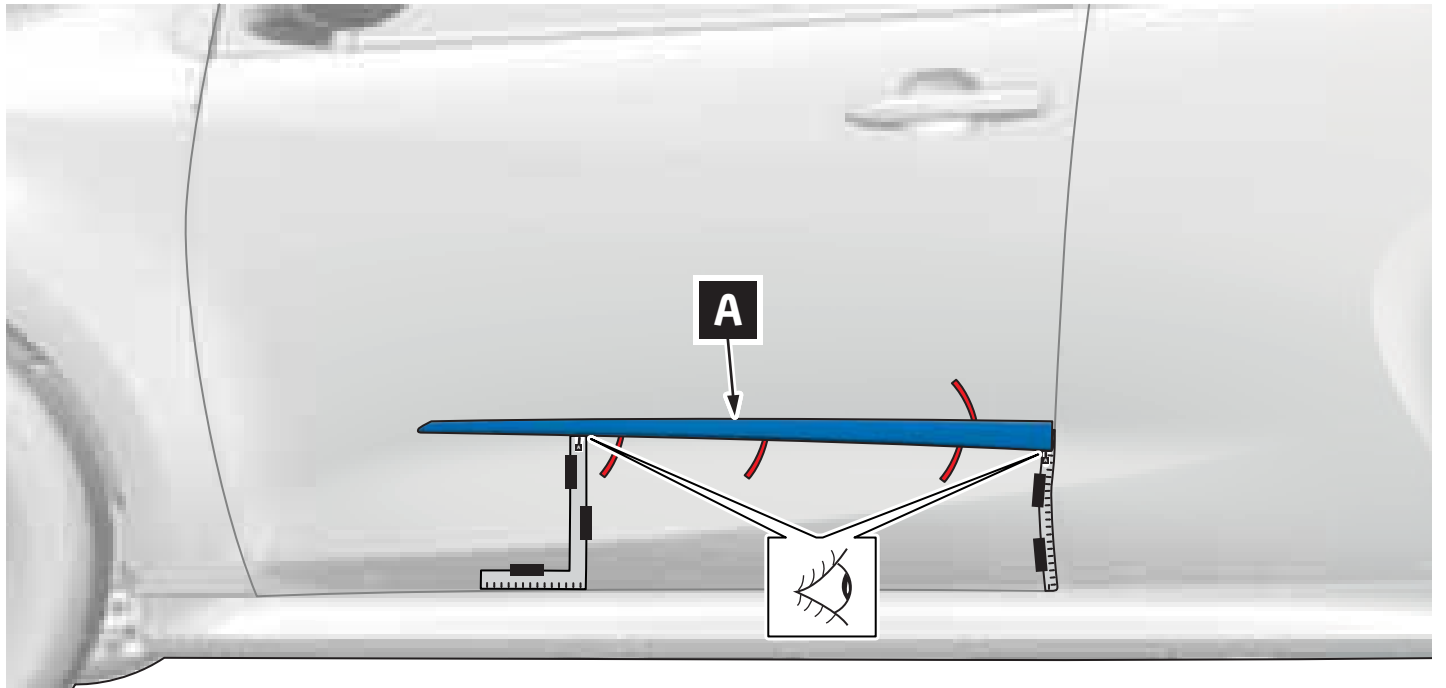

6

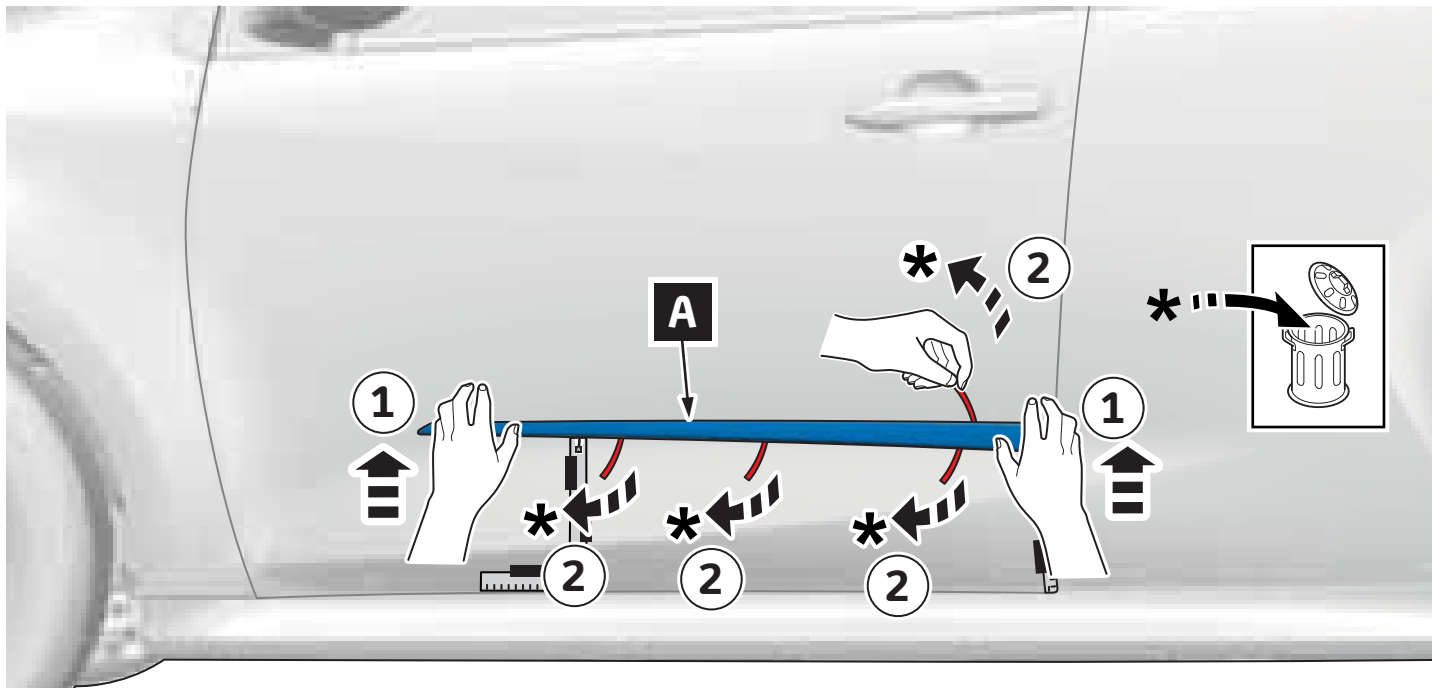

7

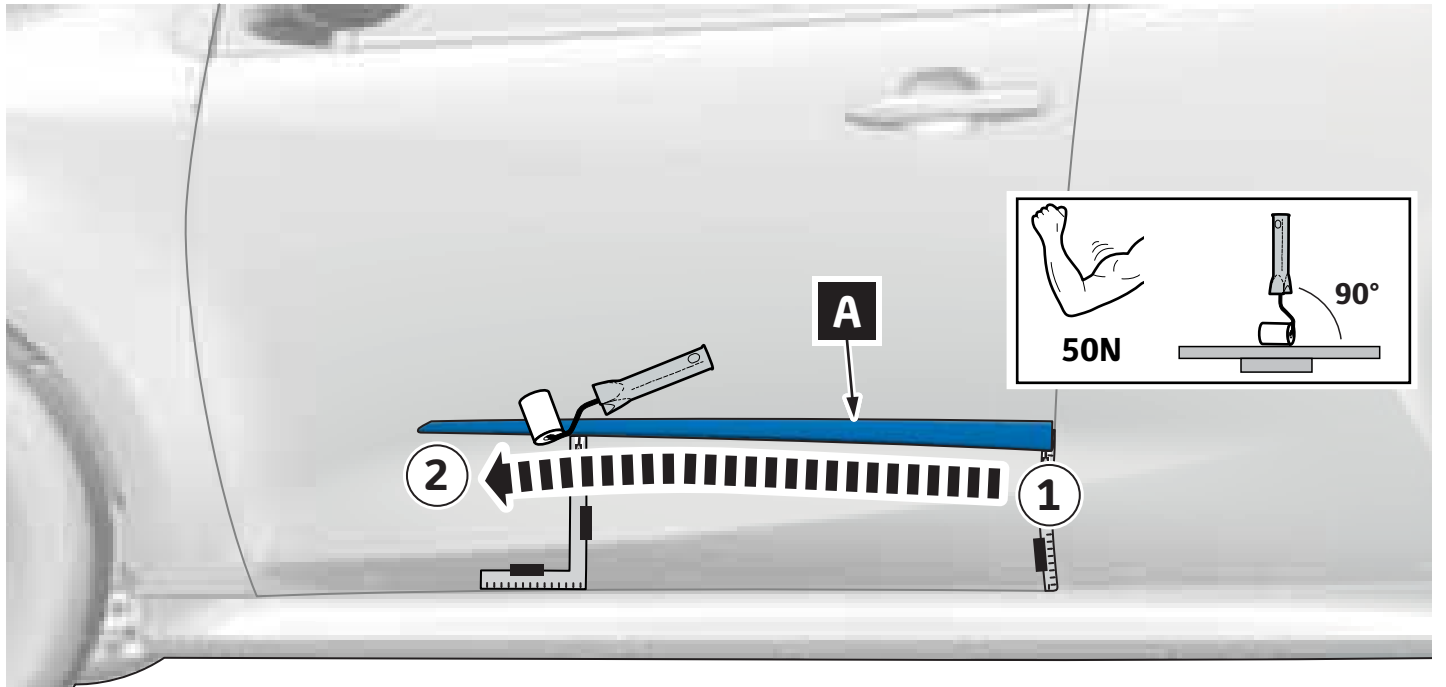

8

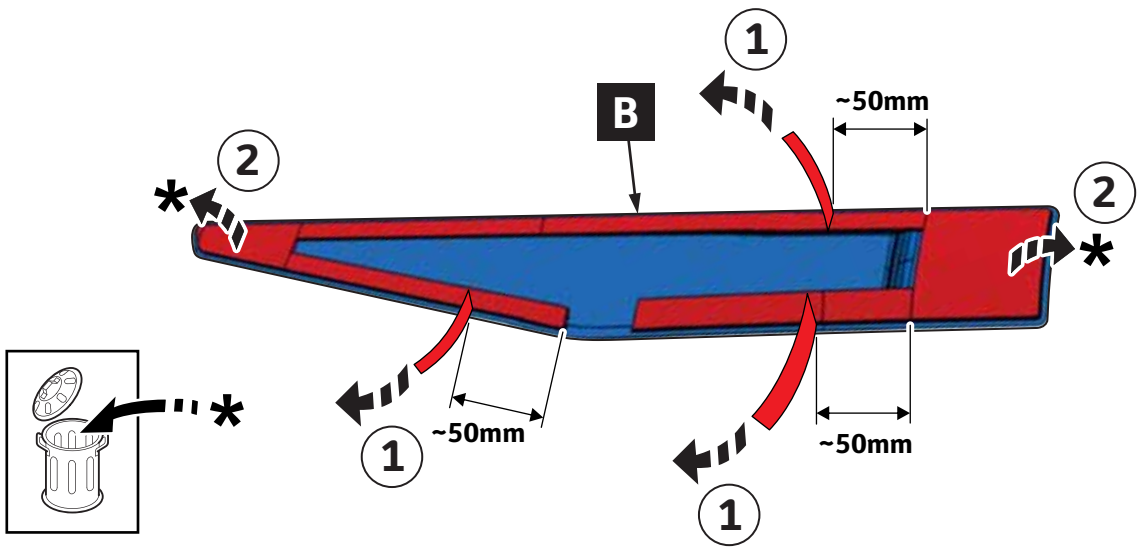

9

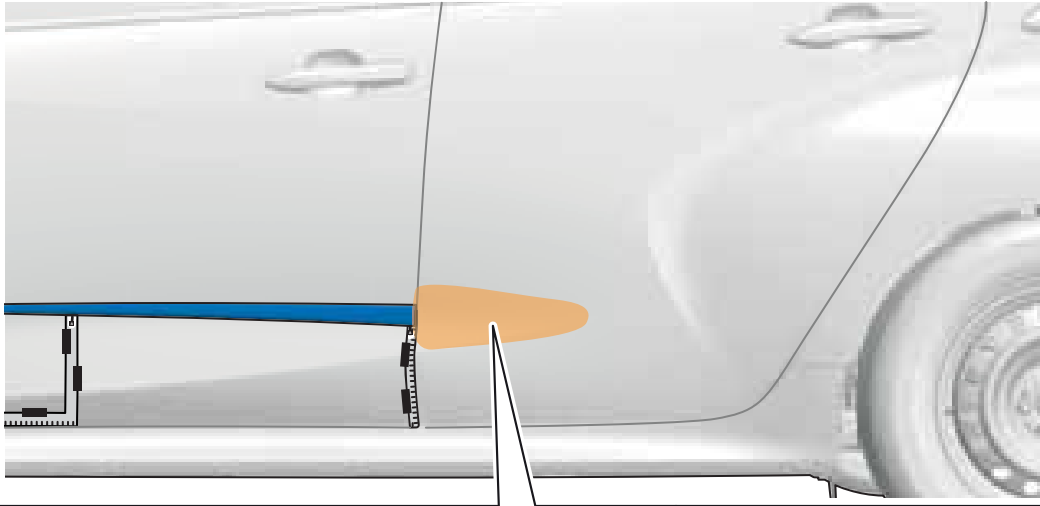

<p>1</p>	<p>< 20°C → 2</p> <p>> 20°C - 40°C → 11</p>	<p>2</p>
<p>3</p>	<p>> 20°C - 40°C → 11</p>	<p>INFO</p>

10

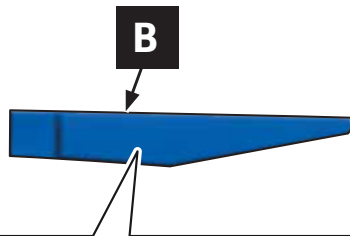

<p>1</p>	<p>< 20°C → 2</p> <p>> 20°C - 40°C → 12</p>	<p>2</p>
<p>3</p>	<p>> 20°C - 40°C → 12</p>	<p>INFO</p>

11

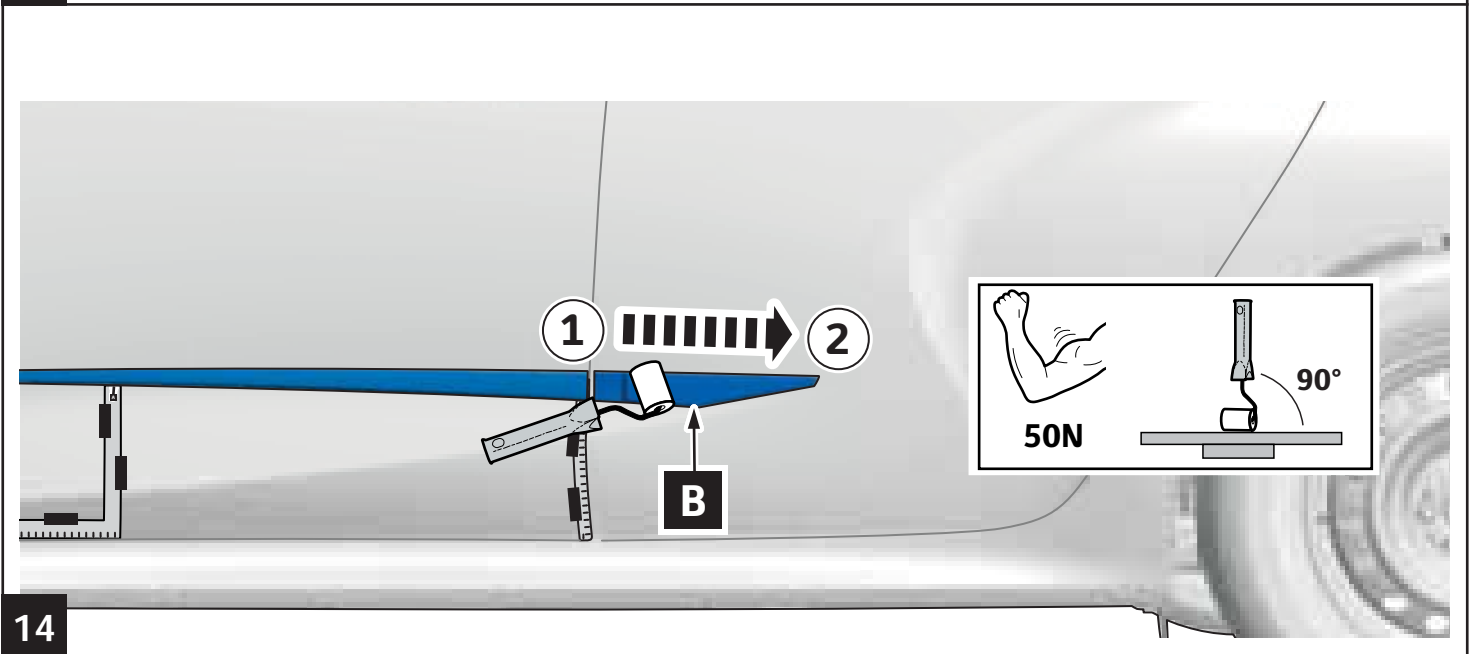
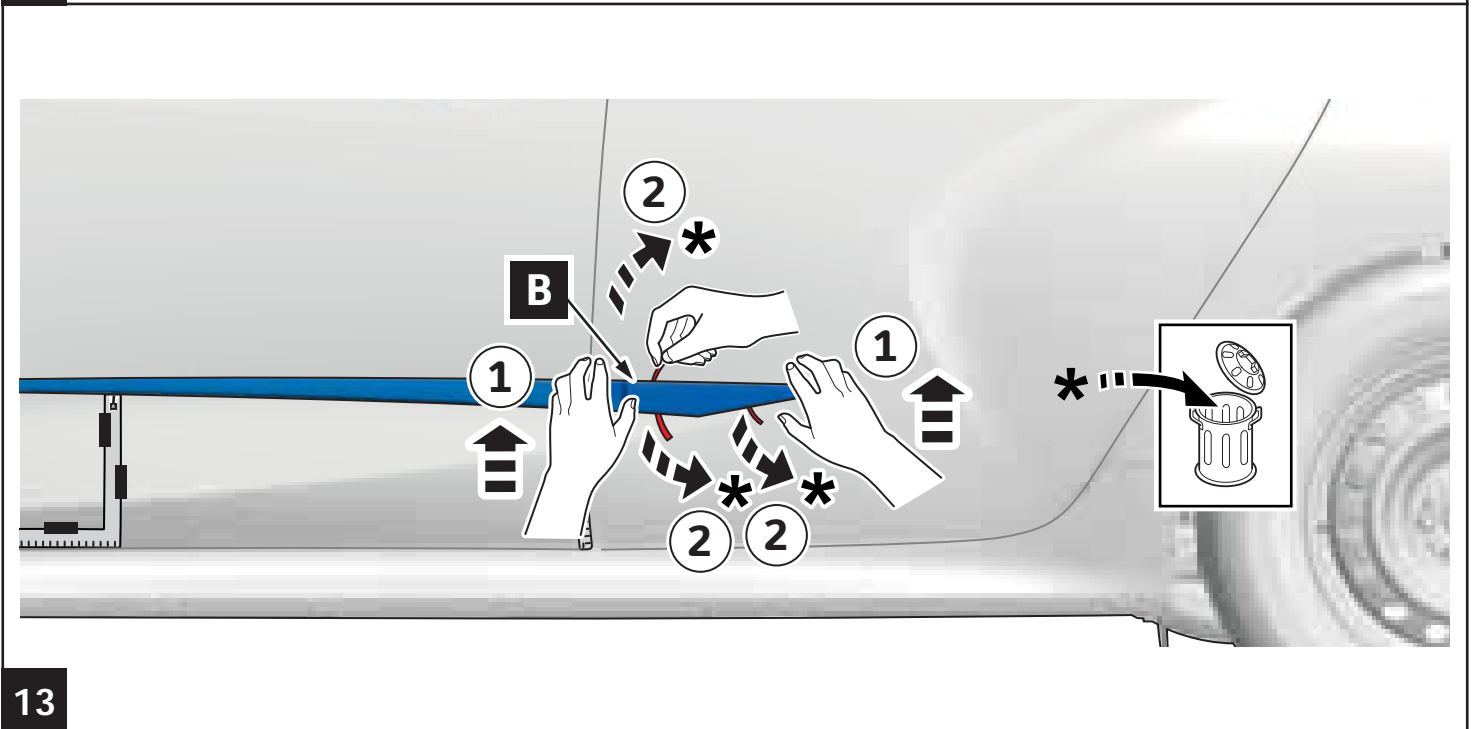
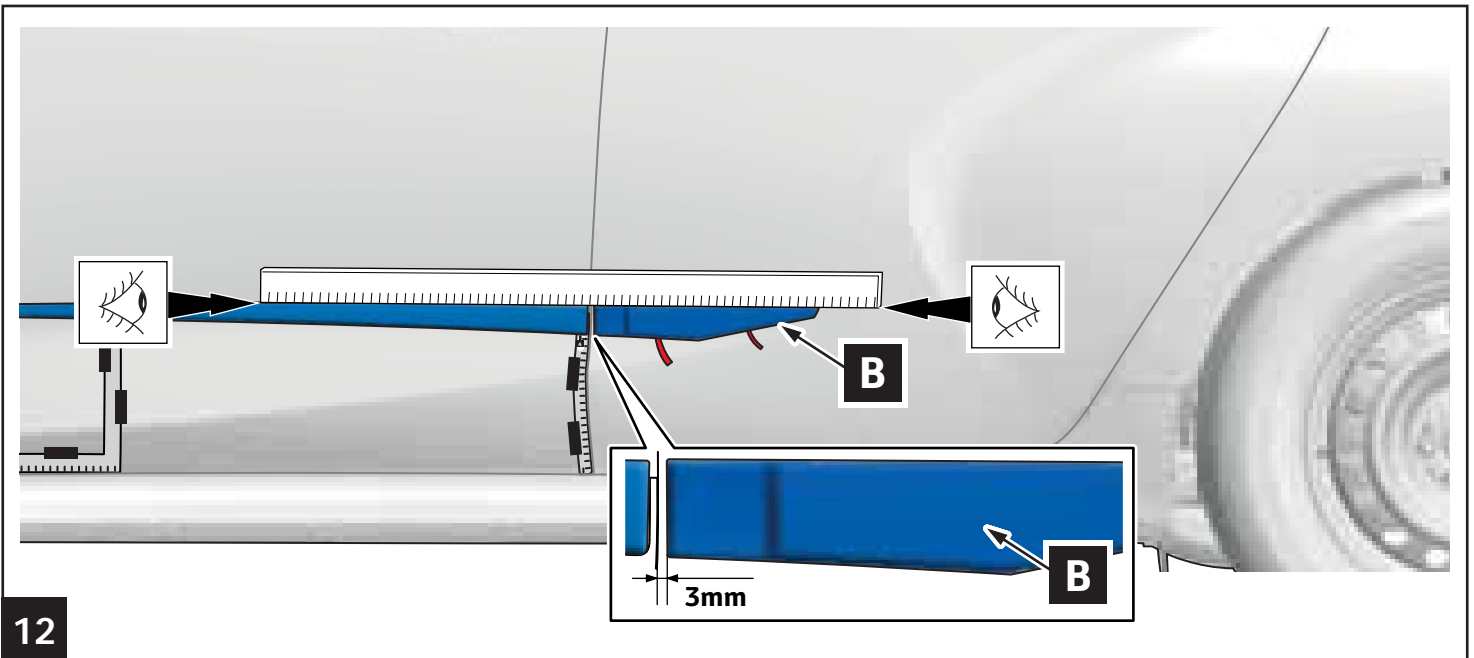

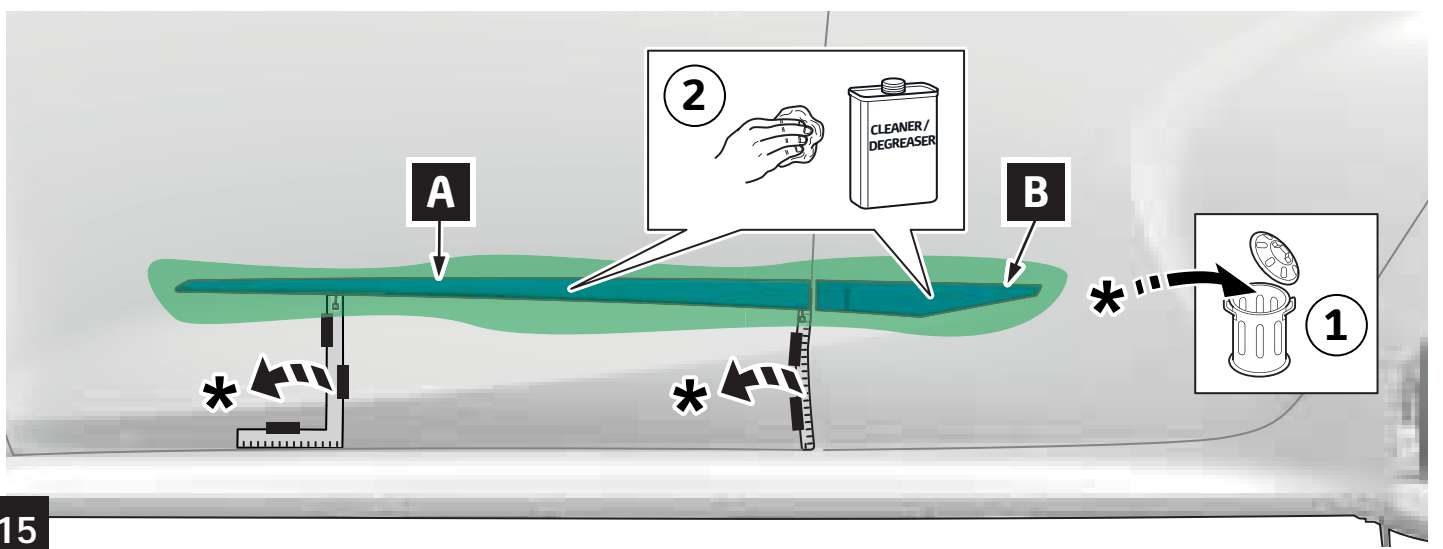

15

Fig.1 → Fig.15

Fig.1 → Fig.15

RHS = LHS
C D A B

16

INFO

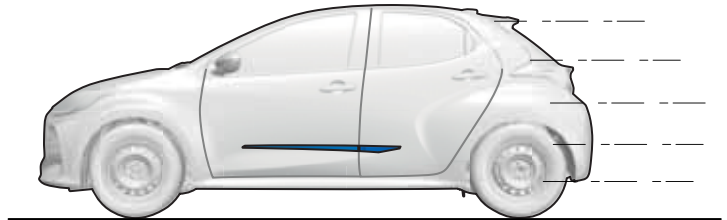
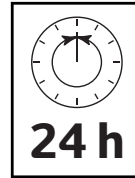
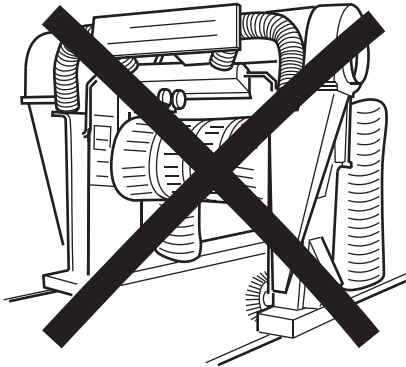
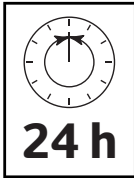

Max. 90 Km/h

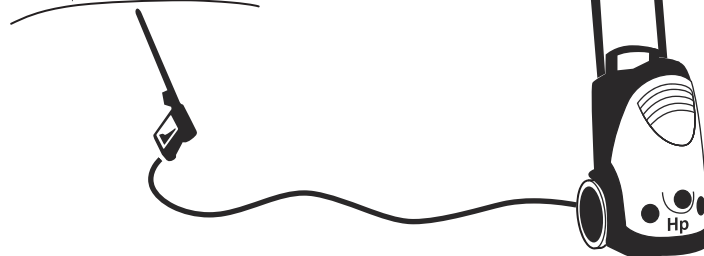
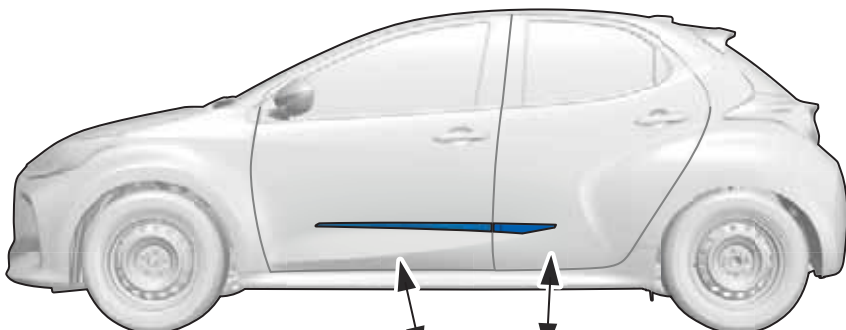

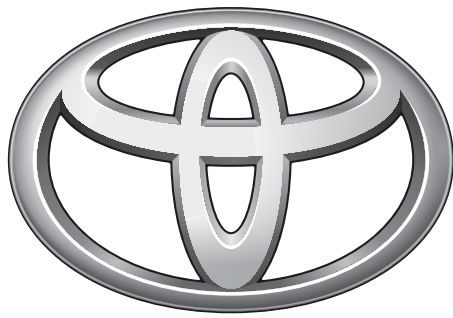

> 50 cm

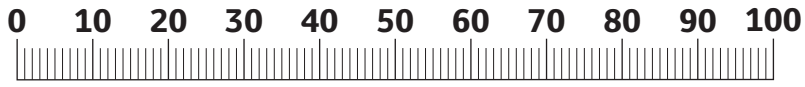

TOYOTA

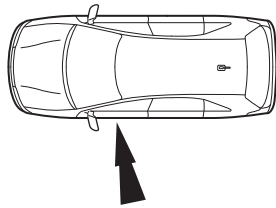

Yaris
****P*11-BH***W**
PW156-0D100-**





CHECK **Print 100%**
Check with Rulers
before use.

A

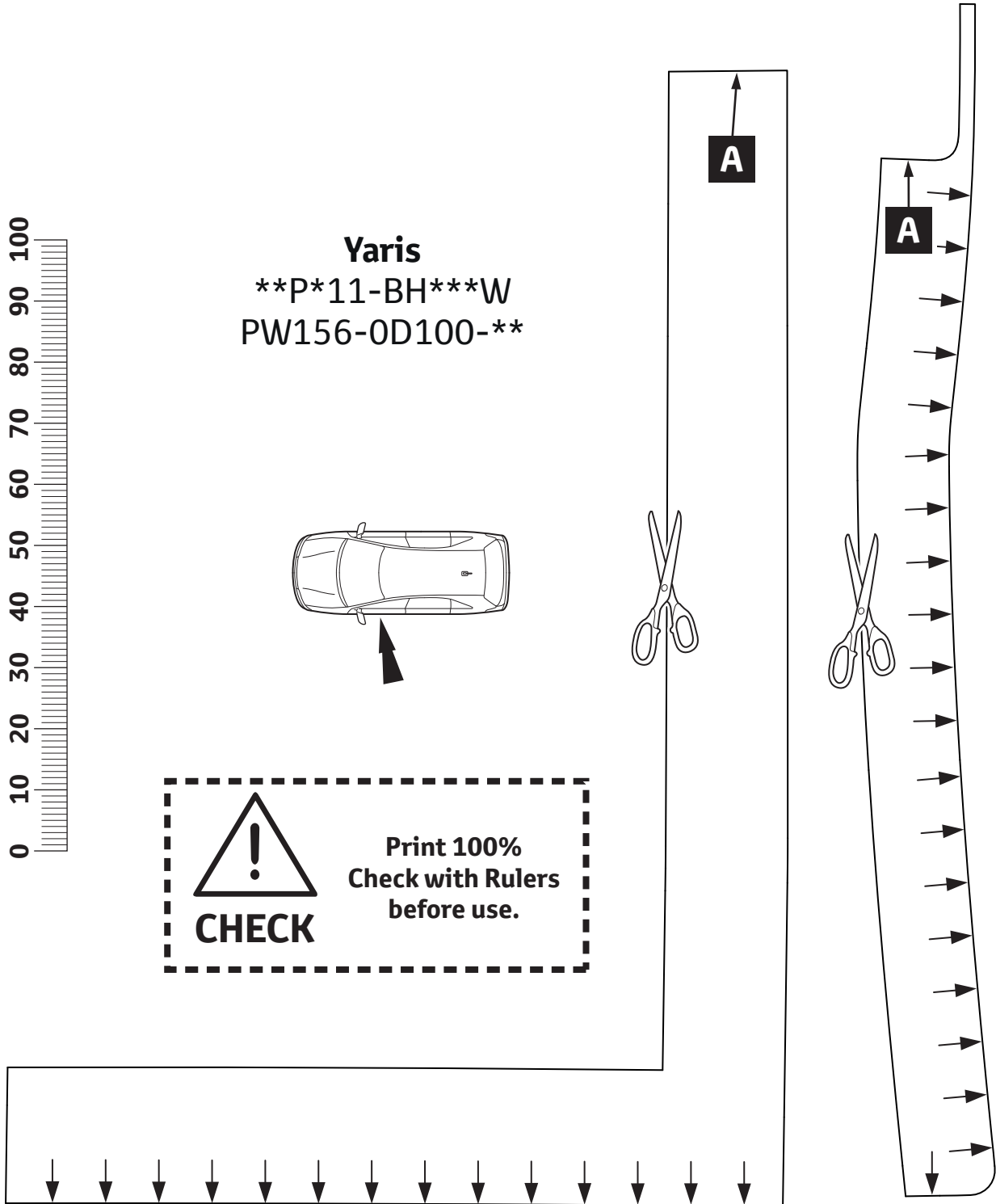

A

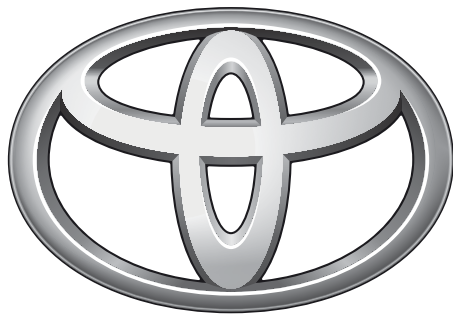



TOYOTA

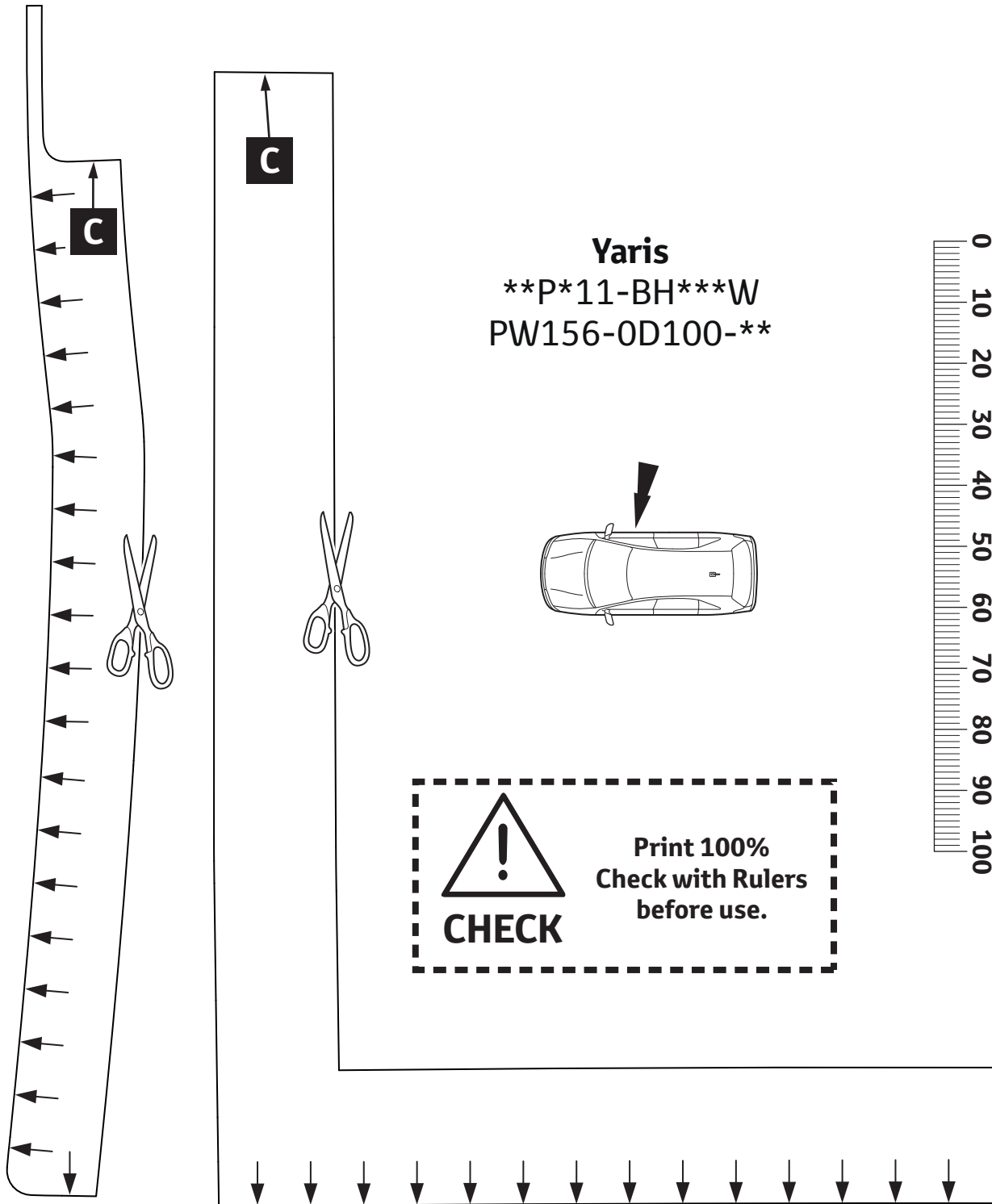
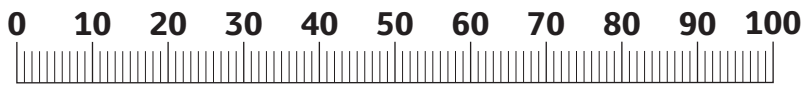

Yaris
****P*11-BH***W**
PW156-0D100-**



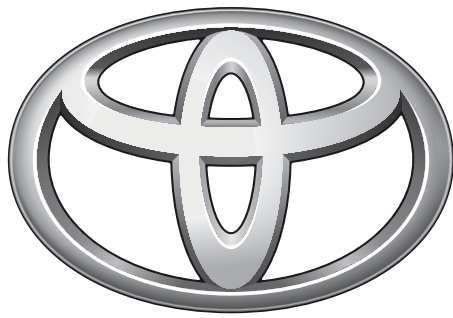

TOYOTA

CHECK SHEET Page 1 of 2



TOYOTA

ALWAYS A
BETTER WAY

Model / Year Yaris 2020/06

Side sills

VIN n°

DURING INSTALLATION

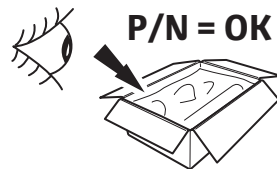

1

AFTER INSTALLATION

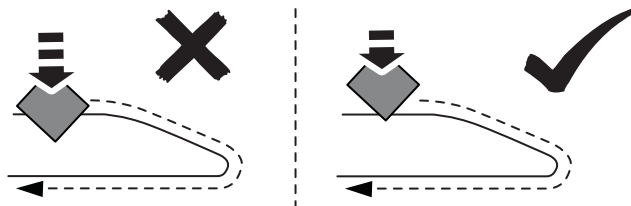

1

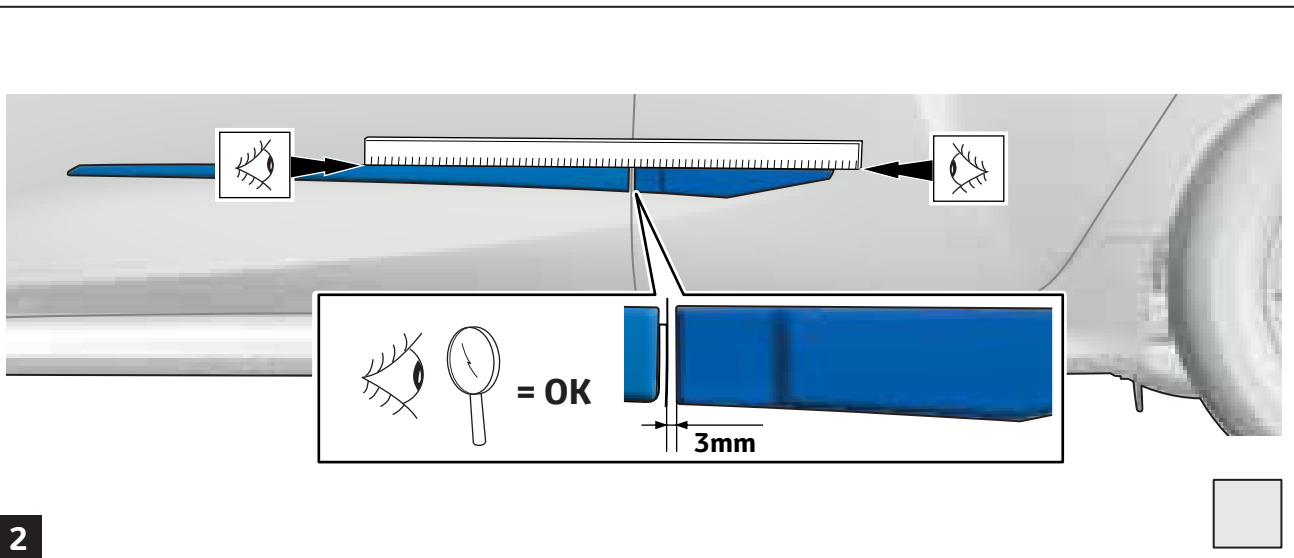

2

Installation Date:

. . / . . /

Technician Name & Signature:

Stamp:

AFTER INSTALLATION

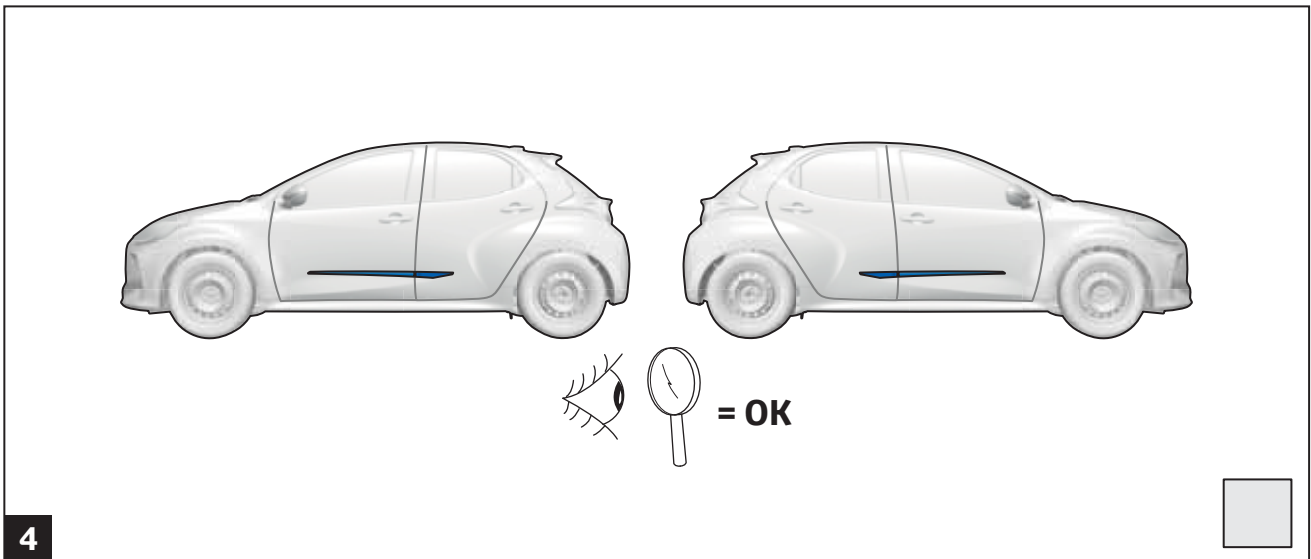
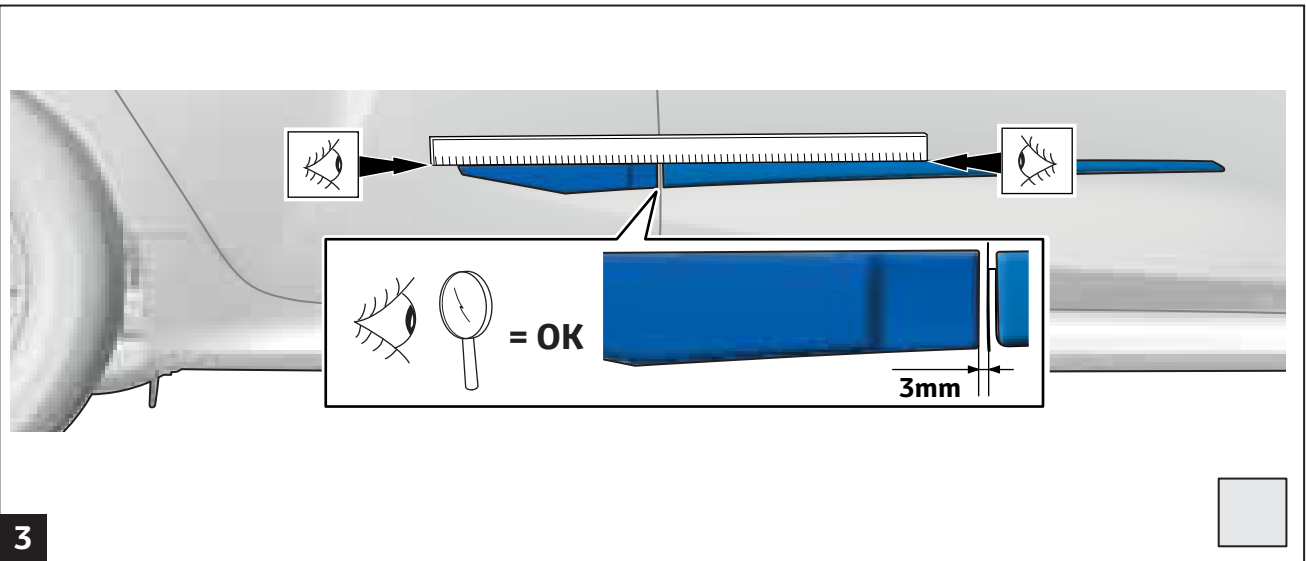

Installation Date:

. . / . . /

Technician Name & Signature:

Stamp: