

# Auris HB/Auris TS

## Rear Bumper Protection Film

### Installation Instructions

Model year: As from 2015/05

Vehicle code: \*\*E18\*\*-DW\*\*\*W

Part number: PW178-02019

Manual reference number: AIM 003 476-1

# Revision Record

Rev. No.	Date	Page	Step	Remarks
△ <sub>1</sub>	20.12.2022	3-7	1-12	Updated to latest standards.
△ <sub>1</sub>	20.12.2022	1, 3	Cover, Kit	Part number updated

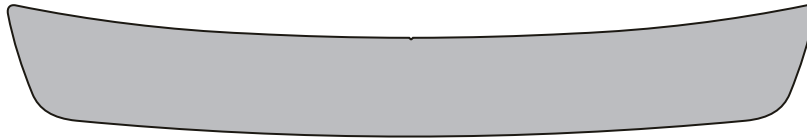

**A**

x1

**OVERVIEW**

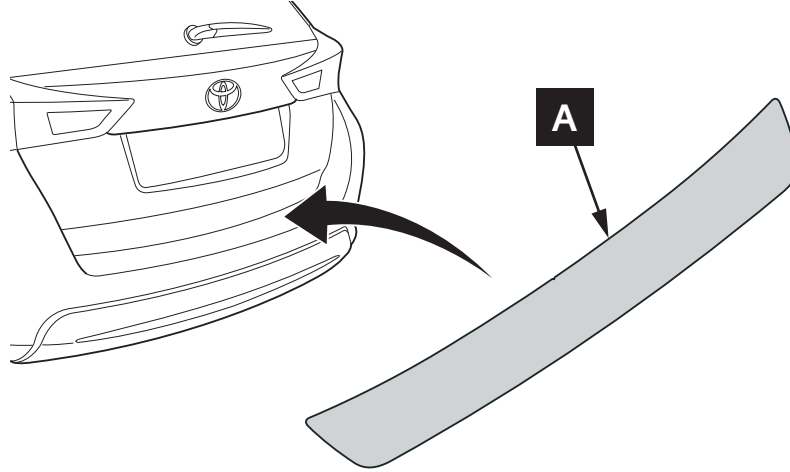

PZ438-00030-90

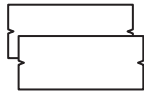
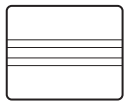

3m Gold Squeegee + felt sticker Qty 2  
**NOT INCLUDED**

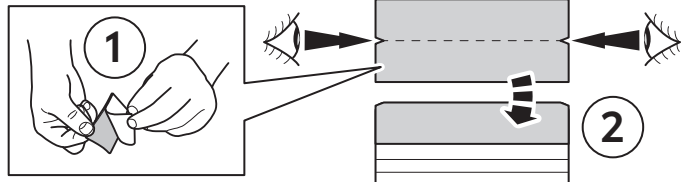

**TOOLS**



**TEMPERATURE SENSOR**

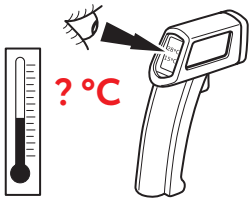

**CONSUMABLES**

**CLEANER / DEGREASER SPRAY**



**AIM 003 516-\***



**VINYL APPLICATION FLUID**



**PW18A-0H000**

**SQUEEGEE**



**PZ438-00030-90**

**For Symbols Explanation SCAN HERE**



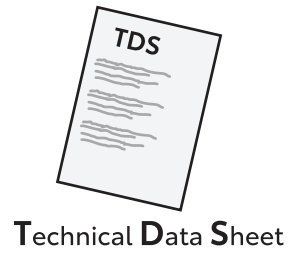

10°C - 28°C

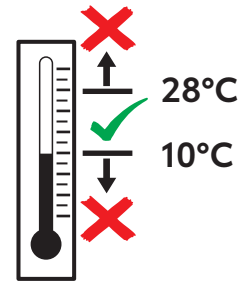
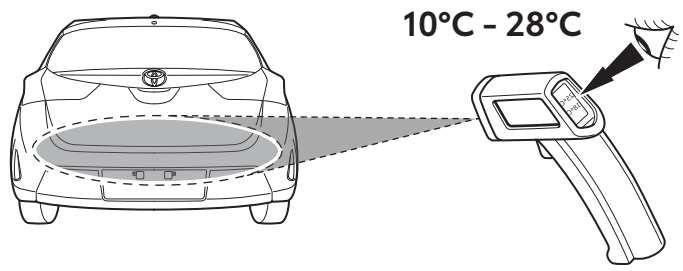

A

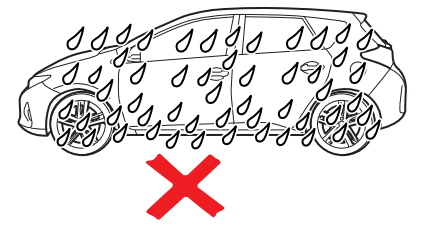
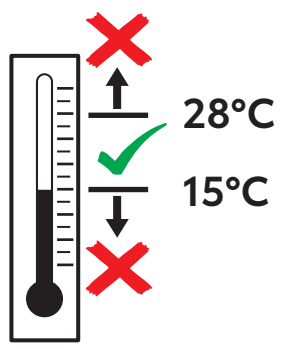
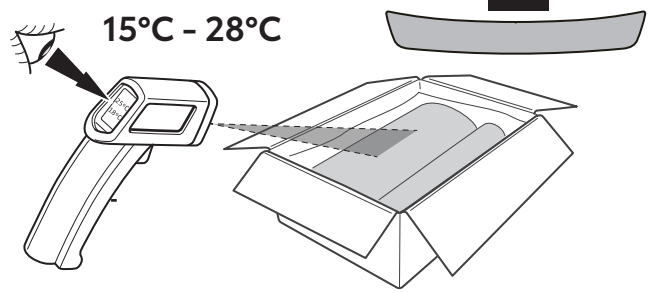

# INSTALLATION INSTRUCTIONS

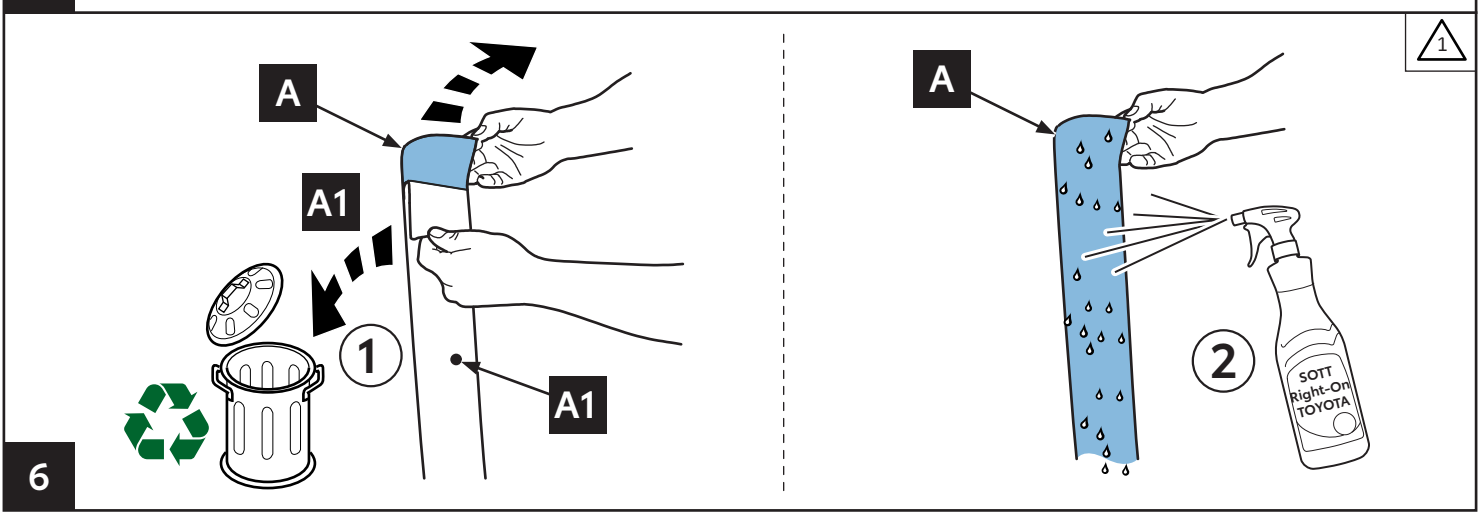
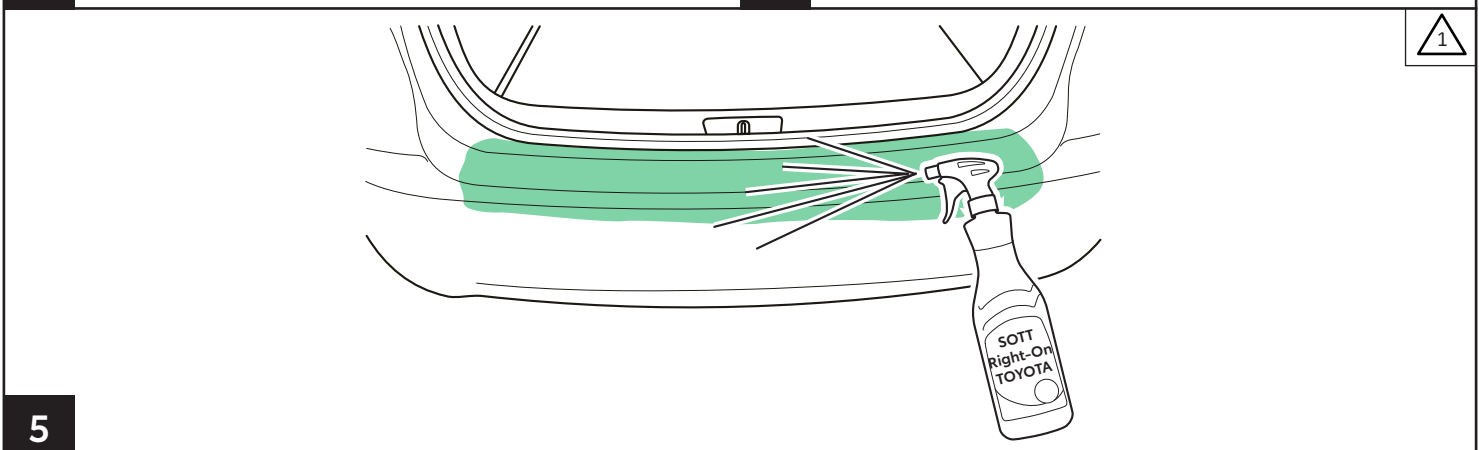
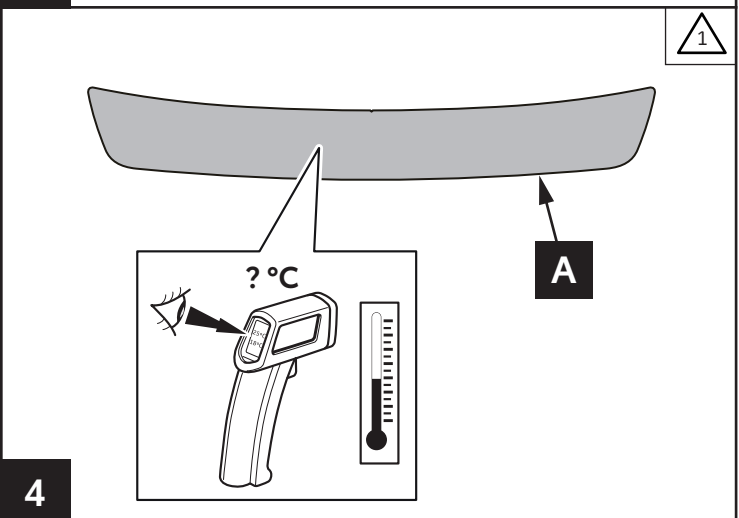
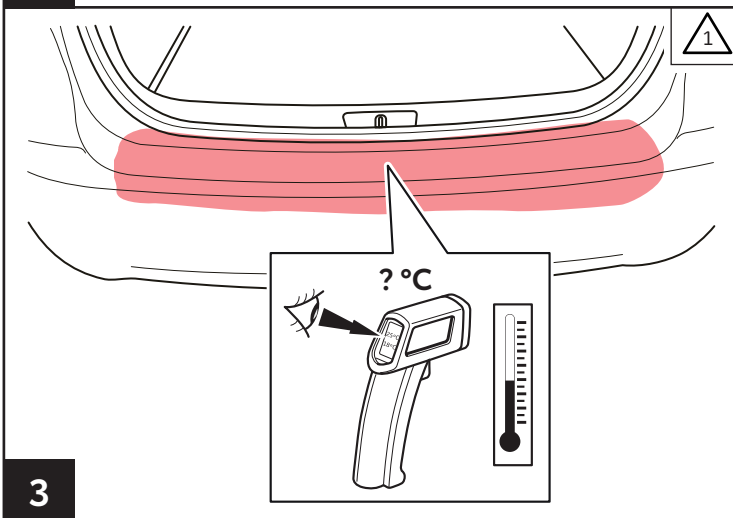
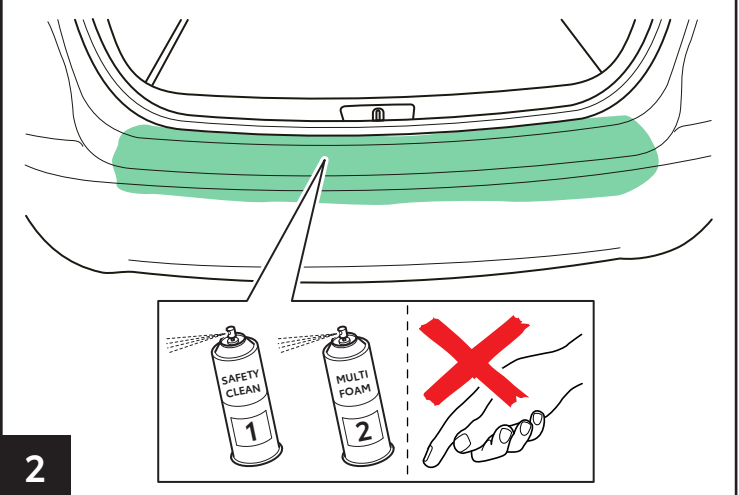
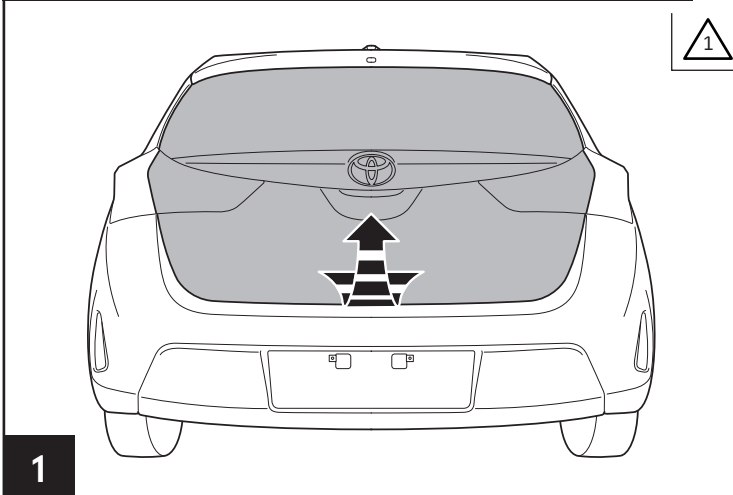

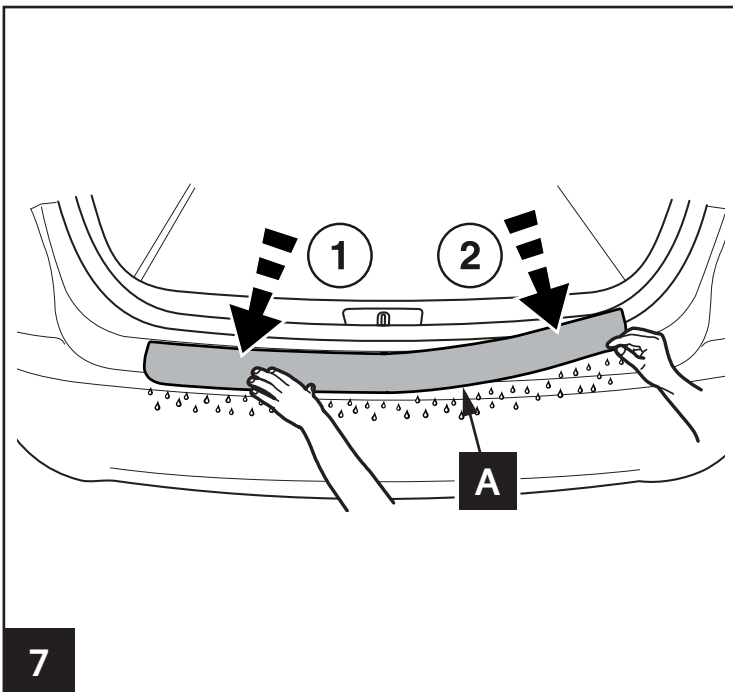

7

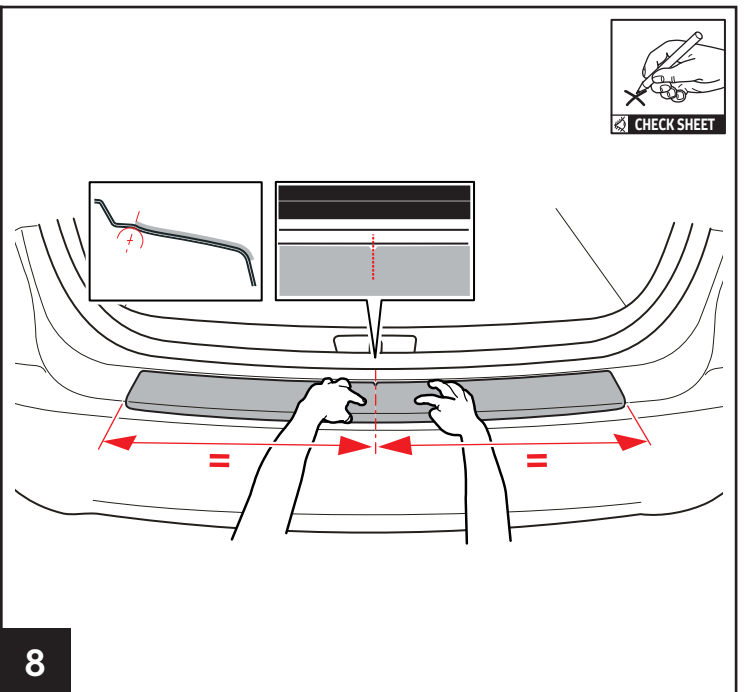

8

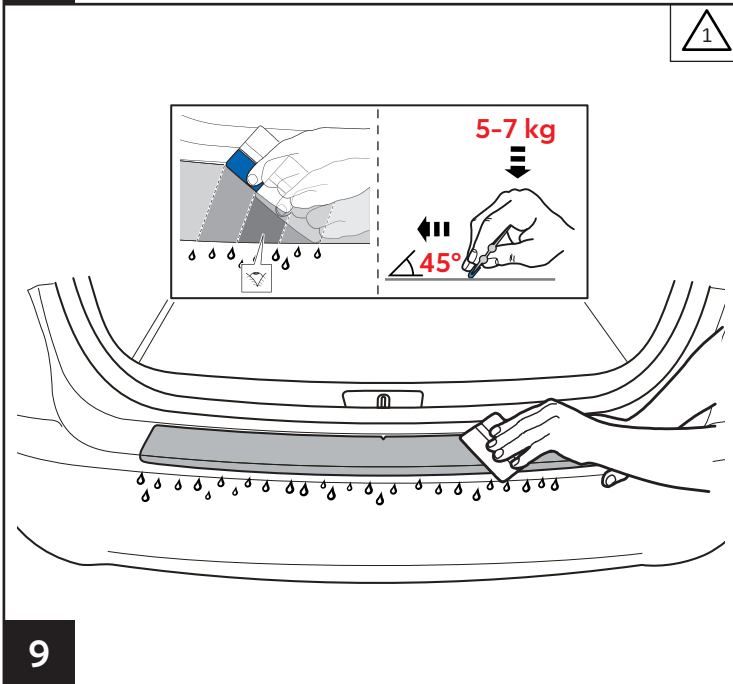

9

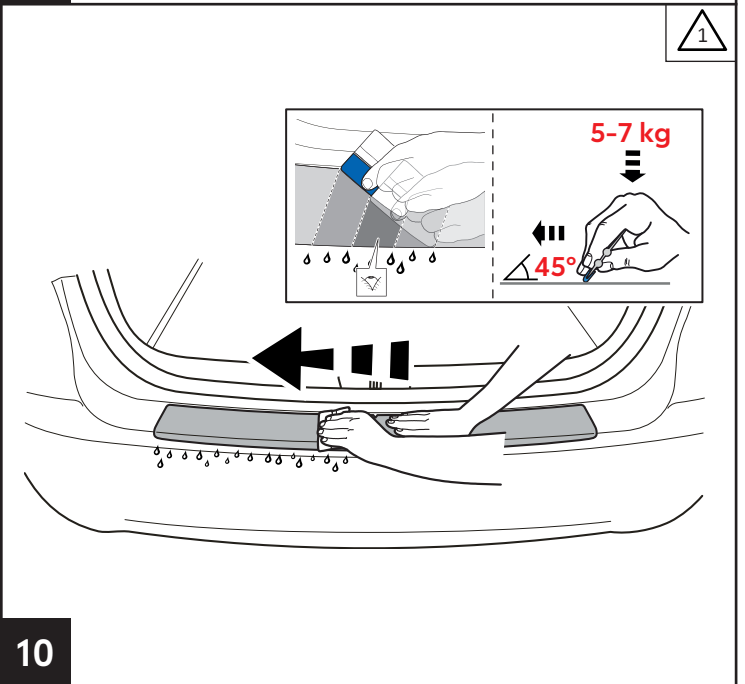

10

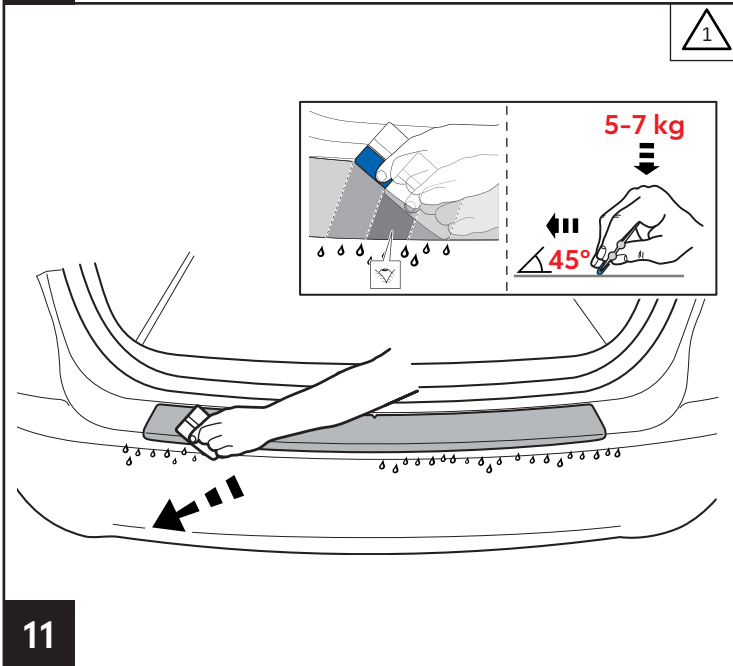

11

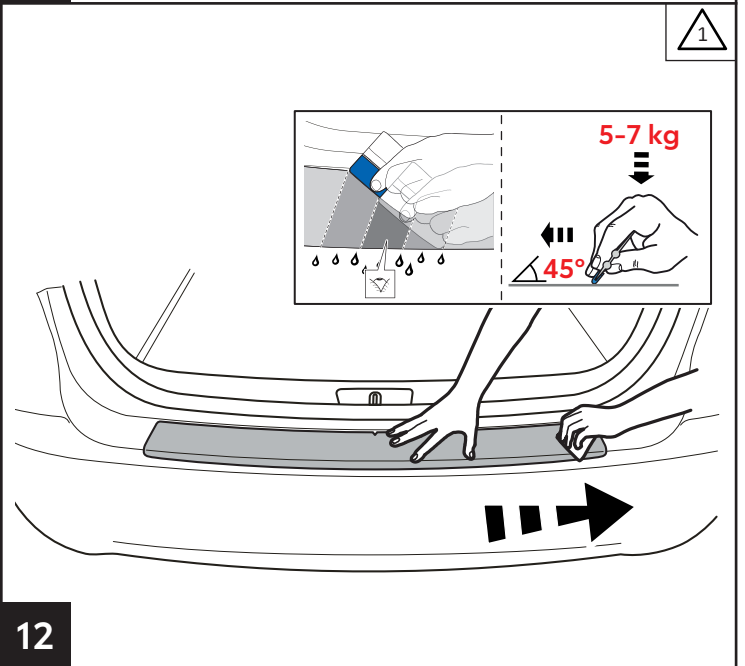

12

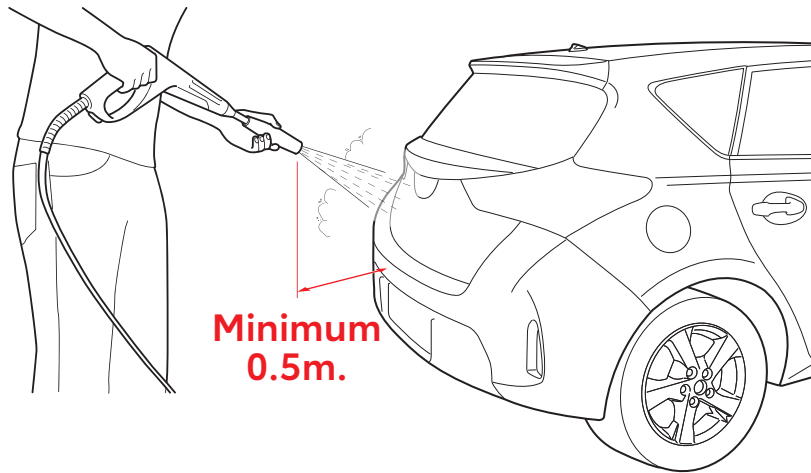
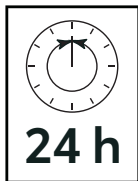
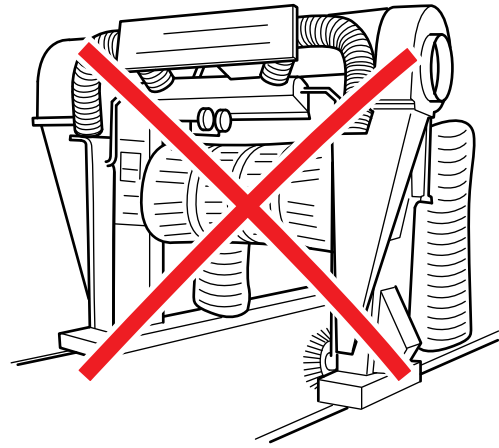
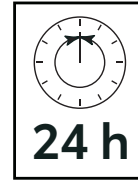
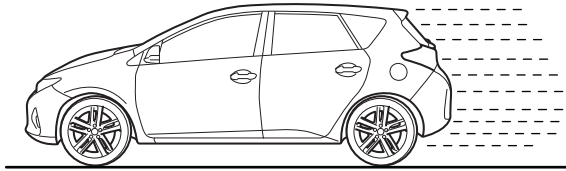
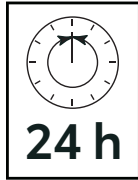

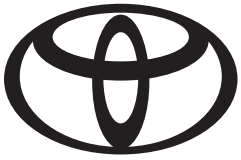

# CHECK SHEET

Page 1 of 1

Model/Year

Auris HB/TS  
As from 2015/05

Rear Bumper Protection Film

VINn°

□ □ □ □ □ □ □ □ □ □ □ □ □ □ □ □ □ □

## DURING INSTALLATION

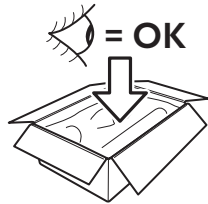

P/N = OK

1

□

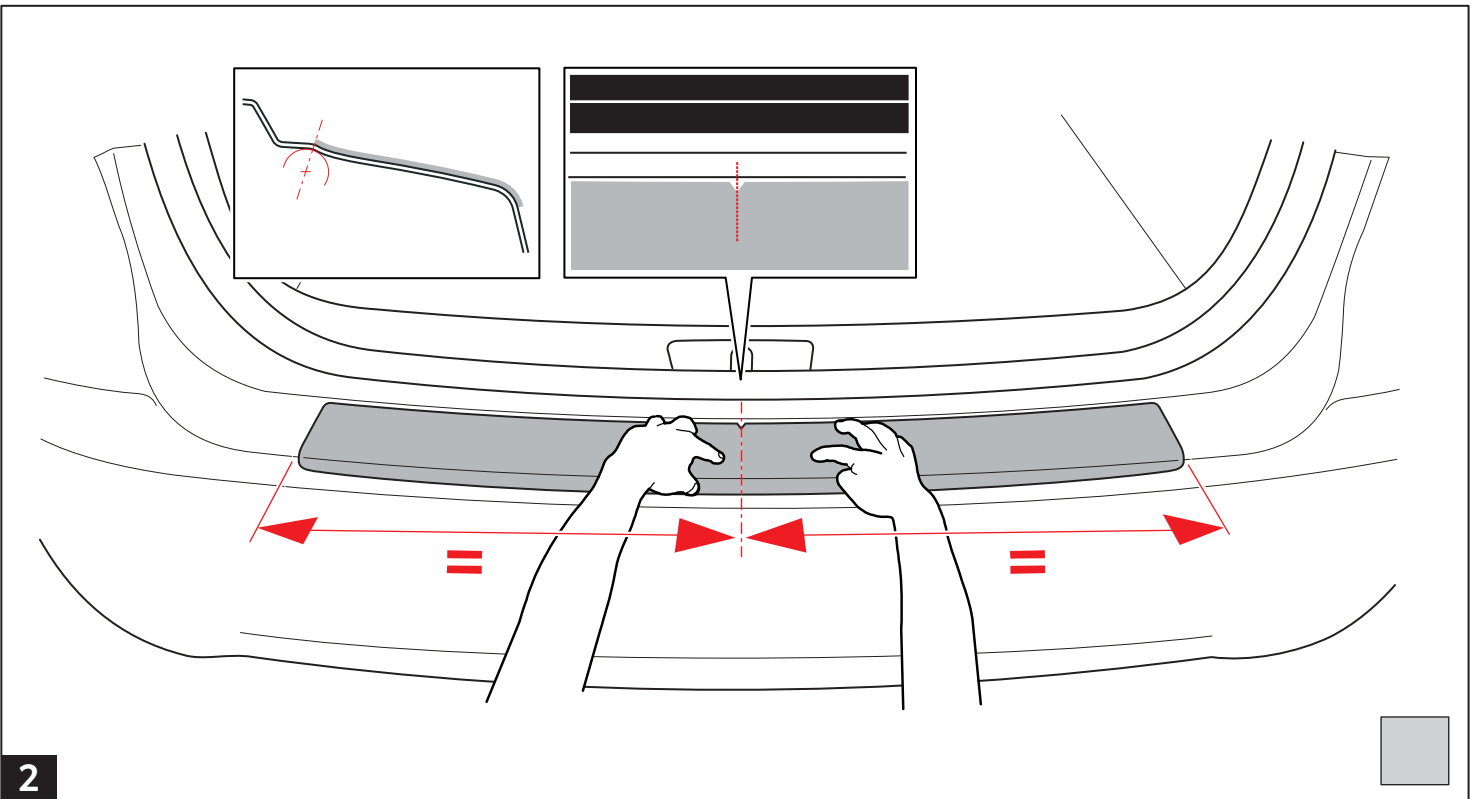

2

□

## AFTER INSTALLATION

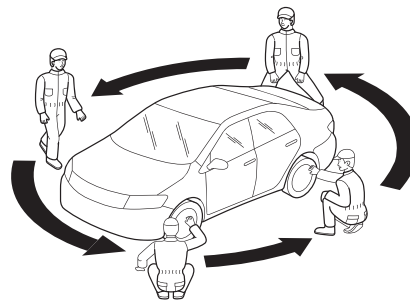
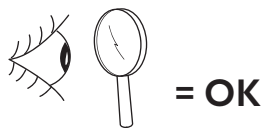

1

□

Installation Date:

.. / .. / .....

Technician Name & Signature:

Stamp: