



**TOYOTA**

ALWAYS A  
**BETTER WAY**

# Toyota C-HR

## Hood Protector

### Installation Instructions

Model year: 2016/10, 2019/10

Vehicle code: \*\*X\*\*\*-AH\*\*\*W / ZGX\*0L-AH\*\*\*X / NGX\*0L-AH\*\*\*X

Part number: PW421-10000

Manual reference number: AIM 003 790-2

# Revision record

Rev. No.	Date	Page	Steps	Remarks
1	24-04-18	1		Vehicle code
2	29-05-19	1, 10		Model year added

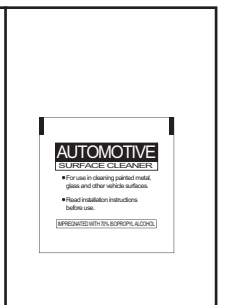
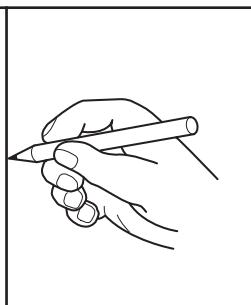
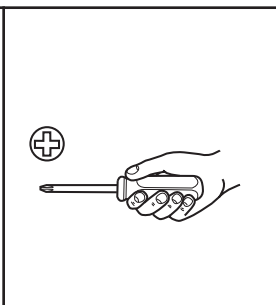
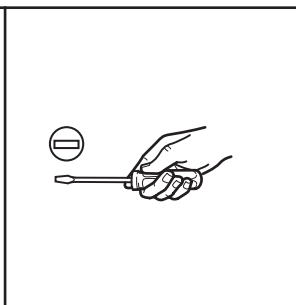
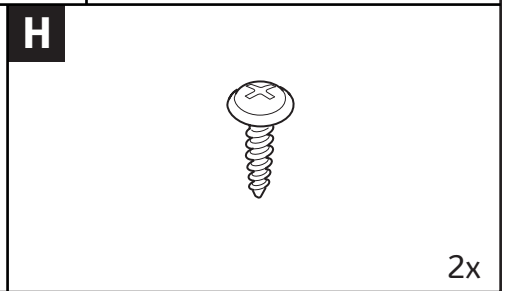
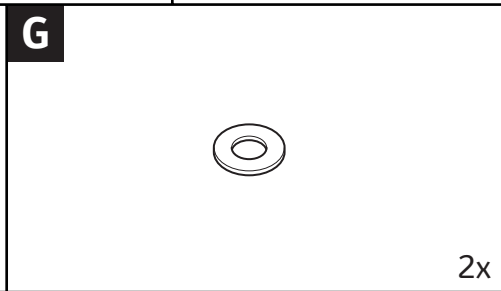
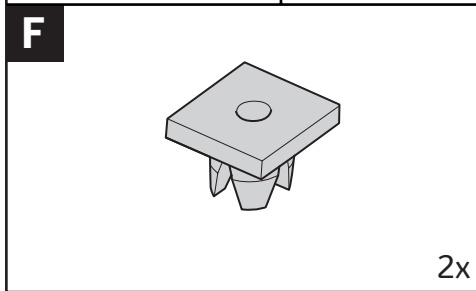
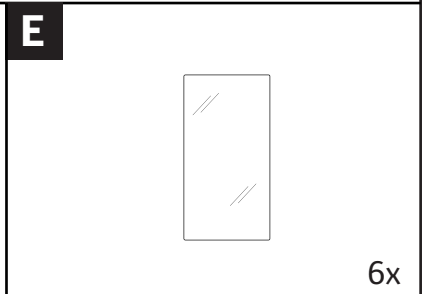
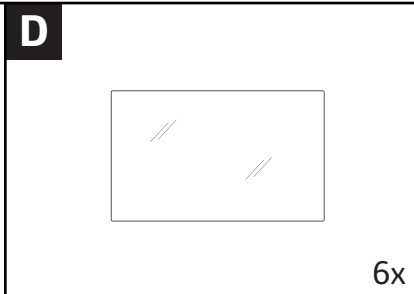
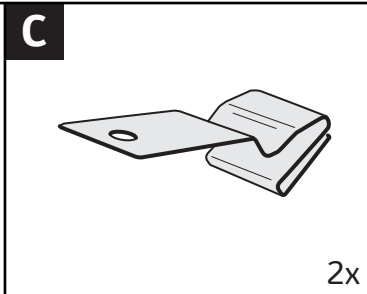
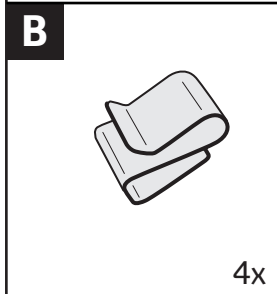
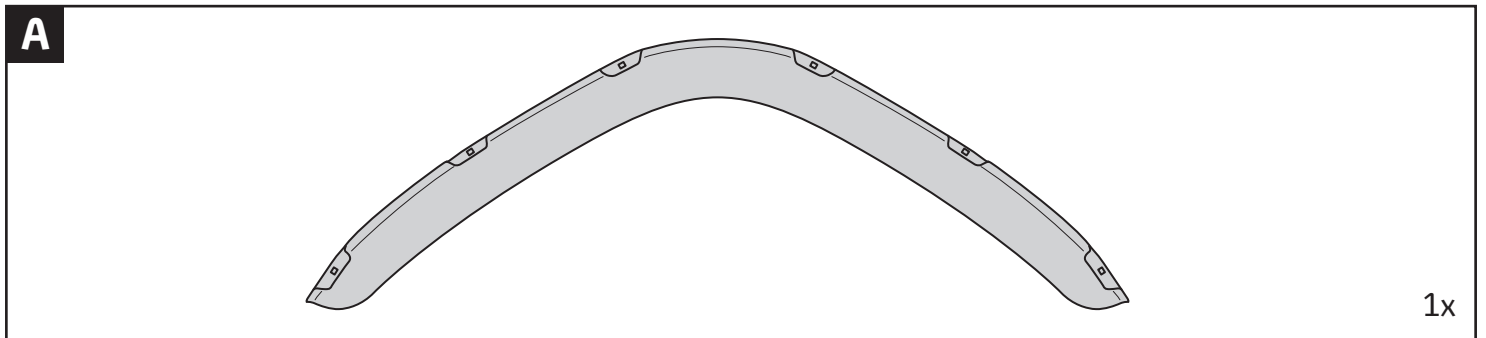



40°C

18°C

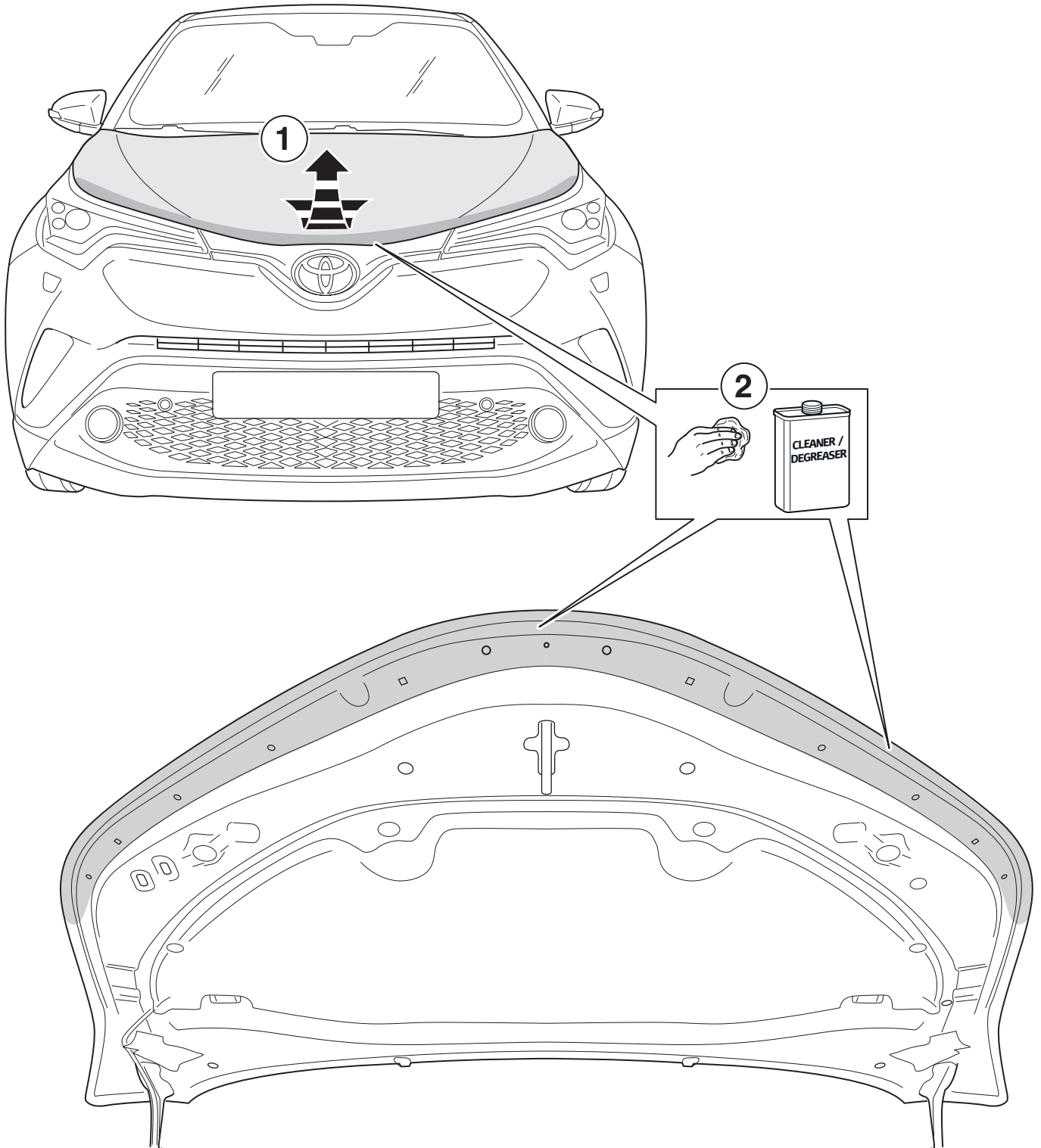

2

6x

2

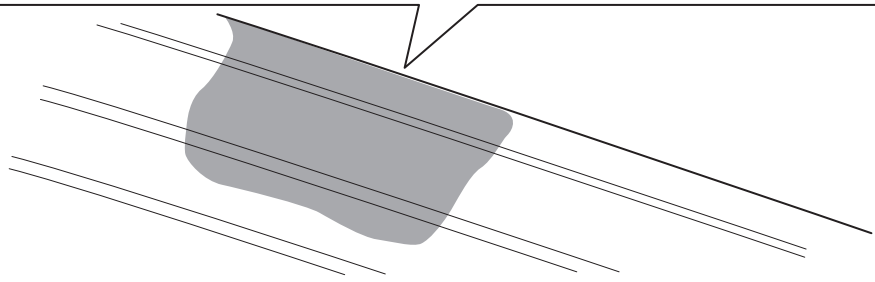
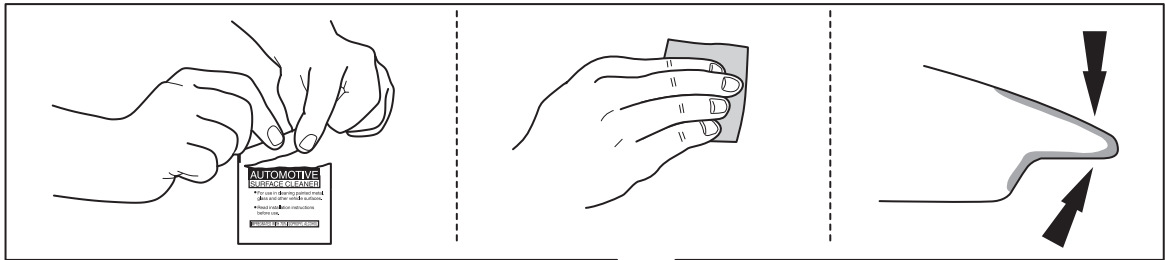

6x

3

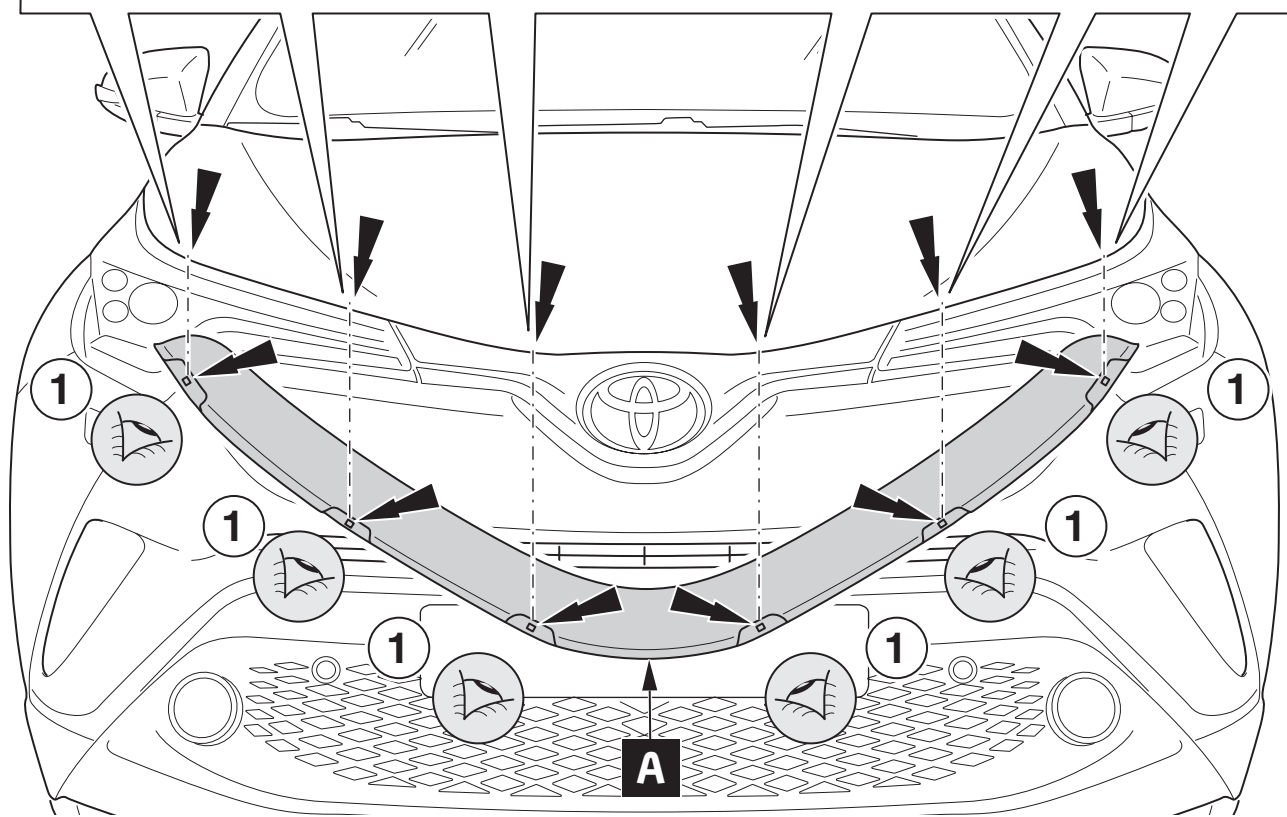
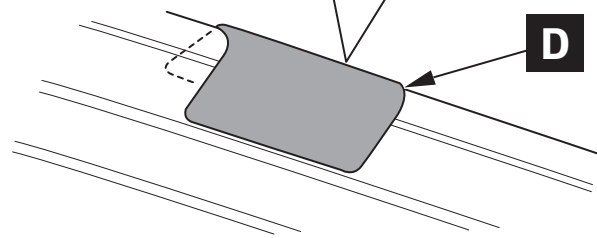
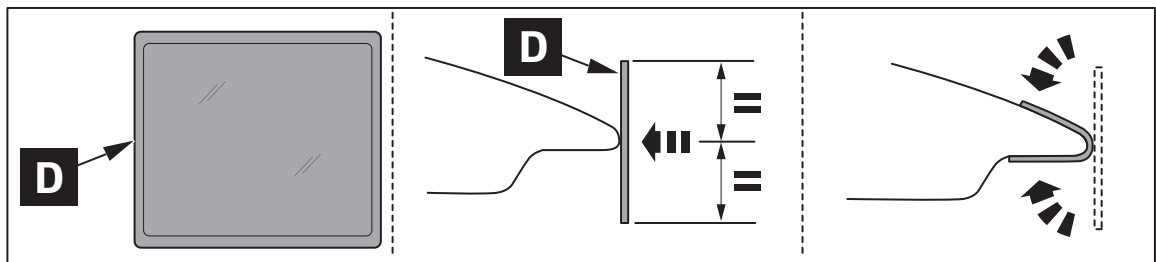

2

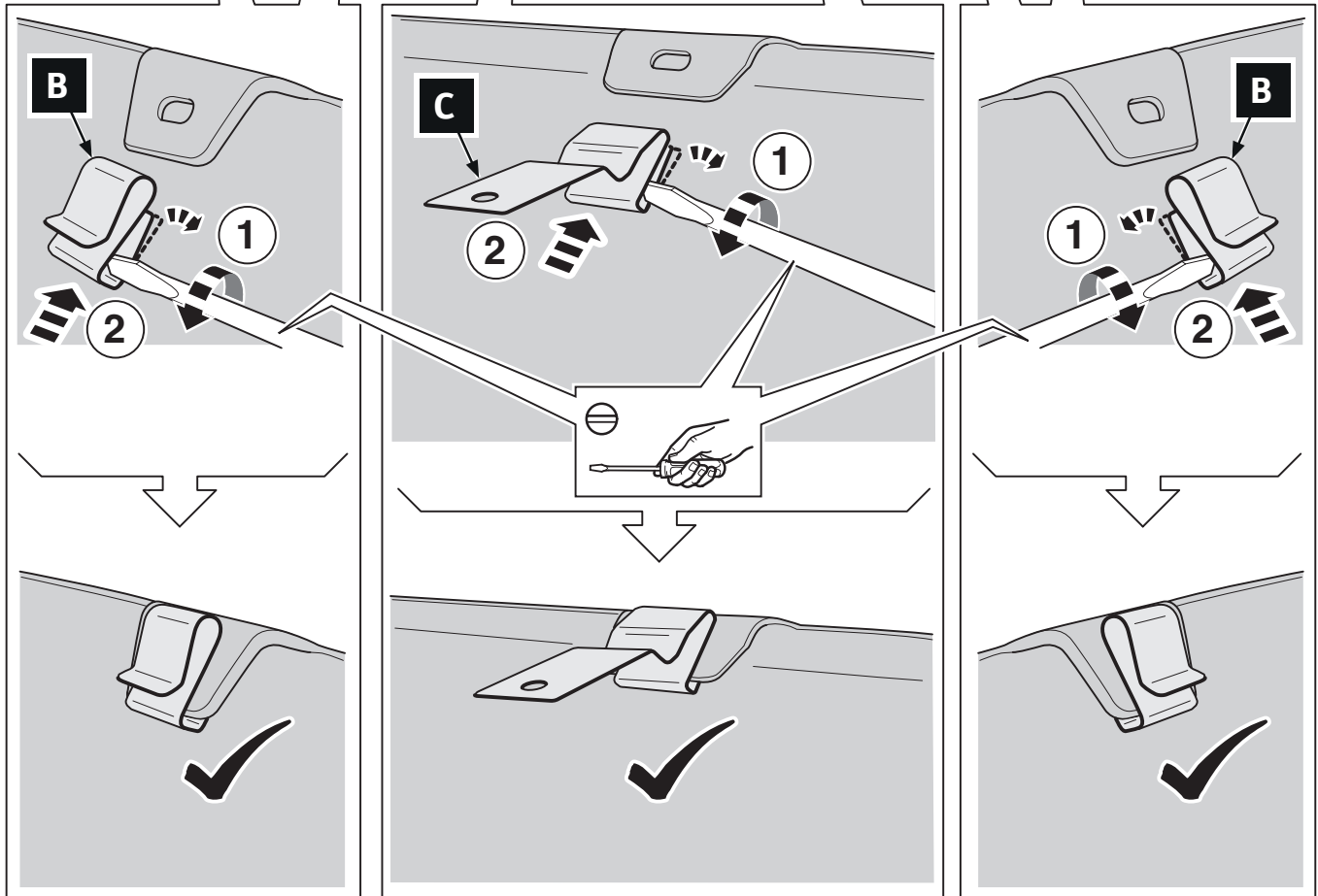
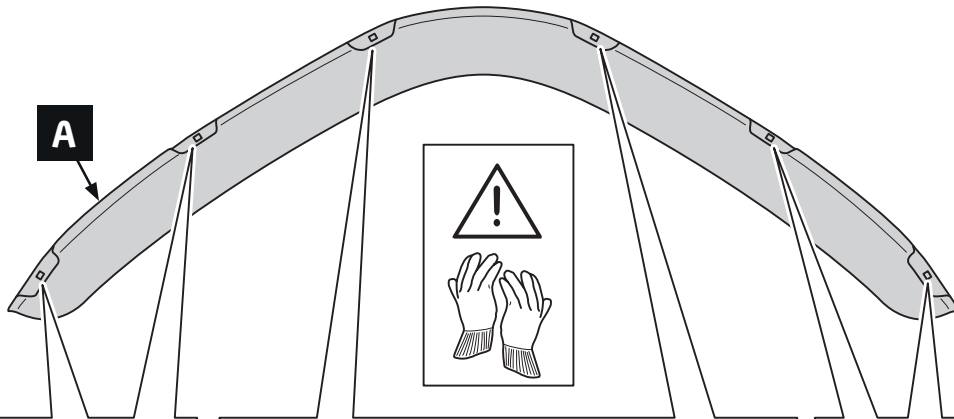
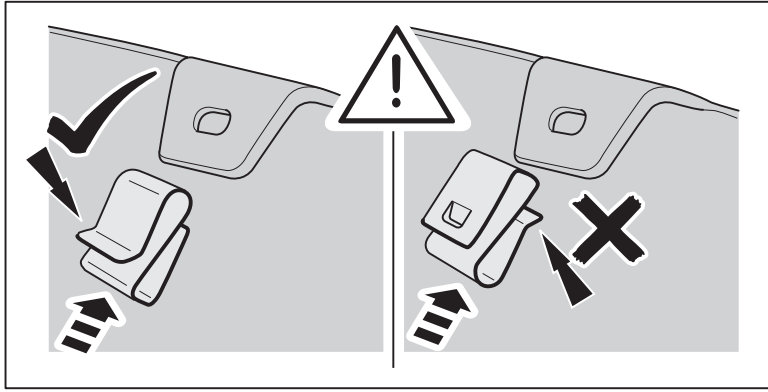

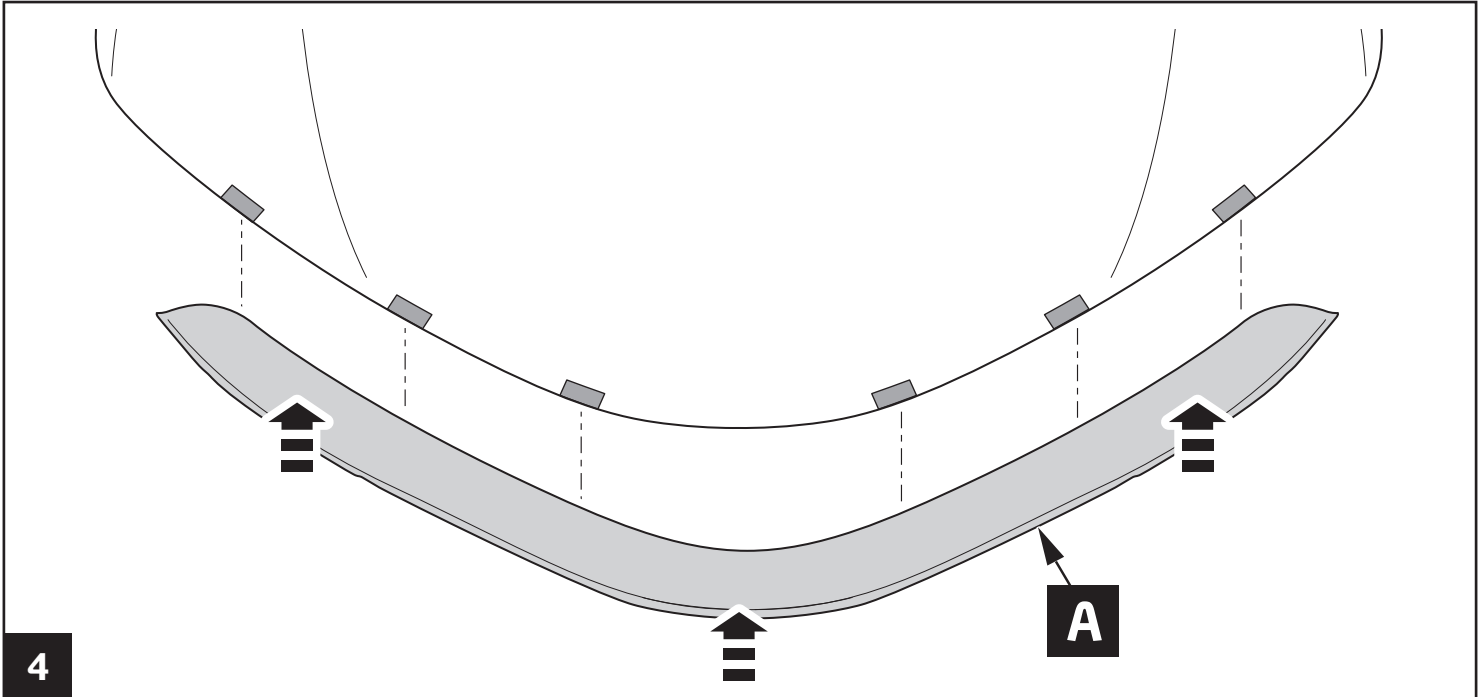

4

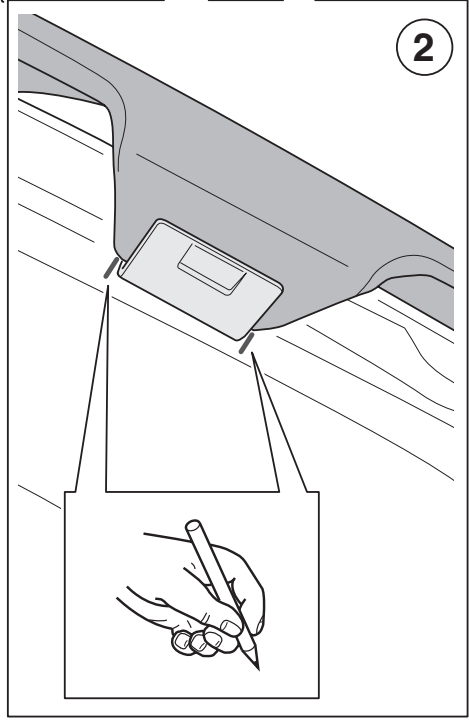
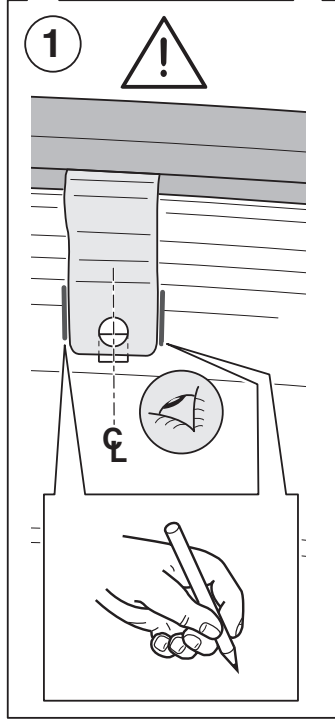
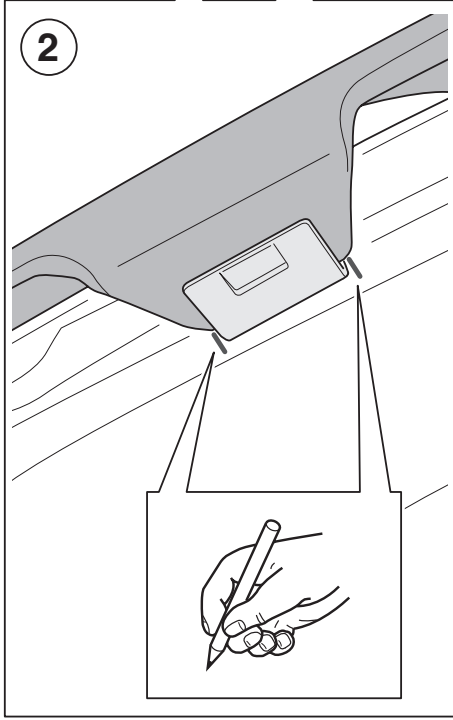
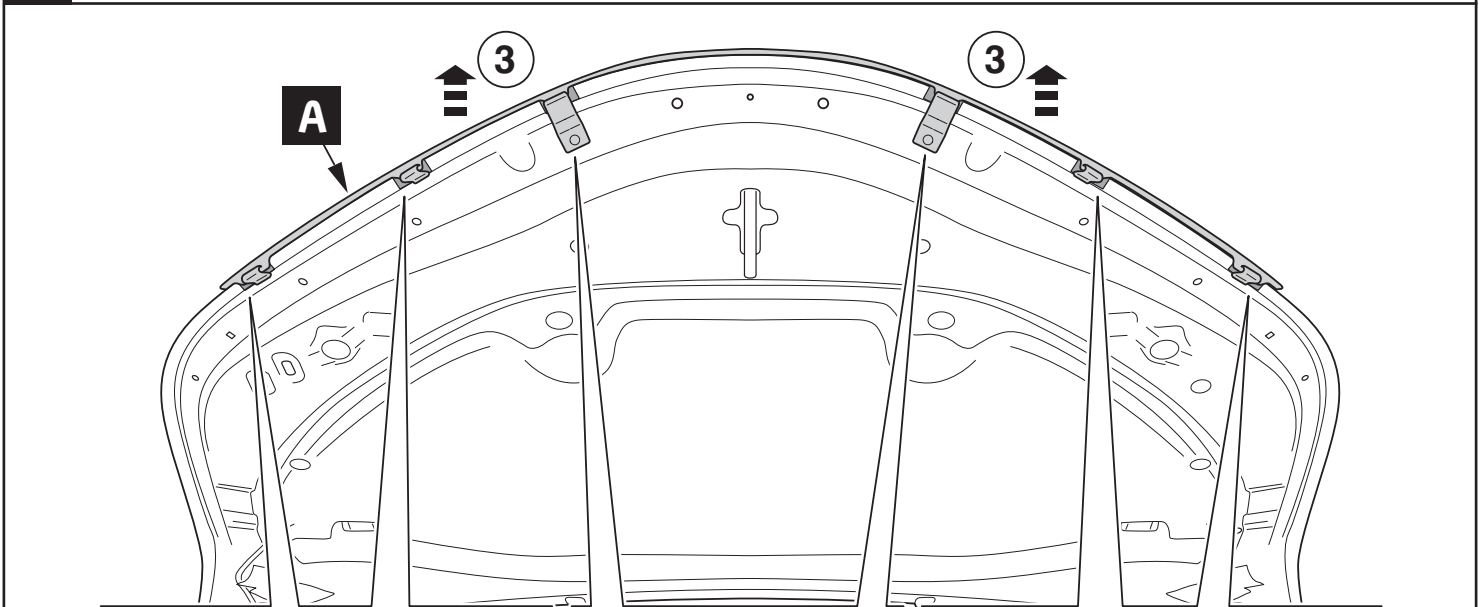

5

6x

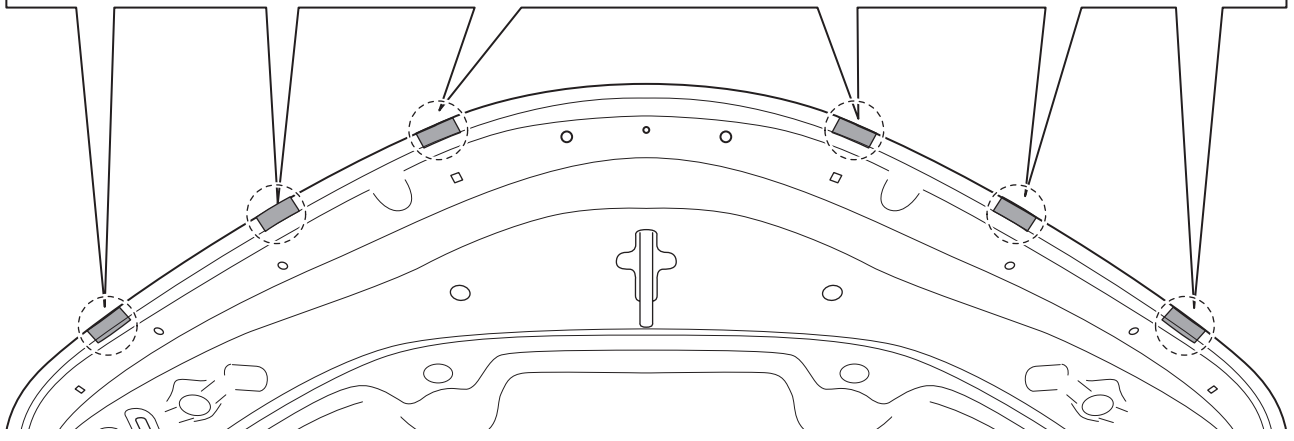
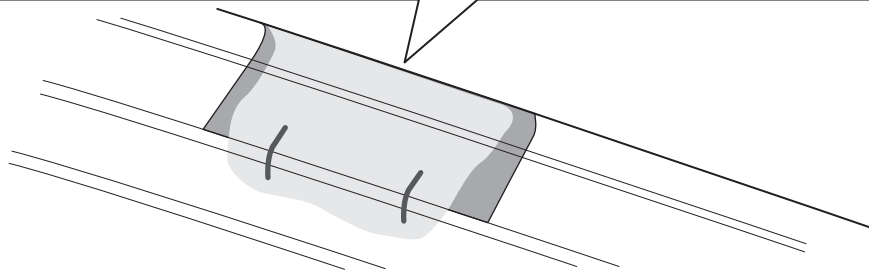
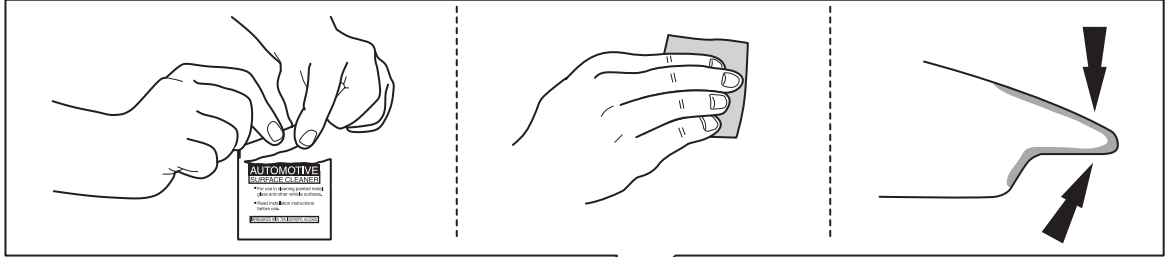

6

6x

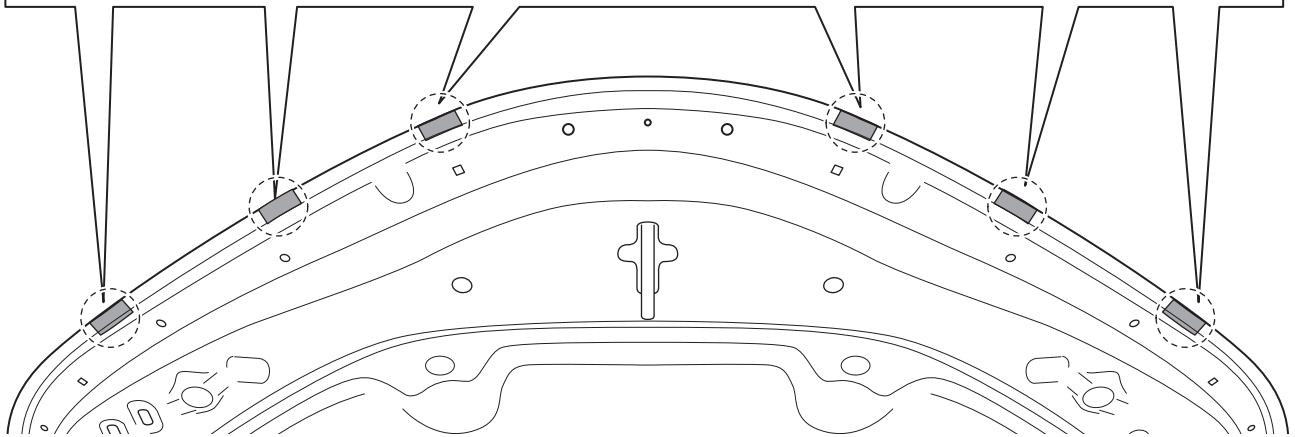
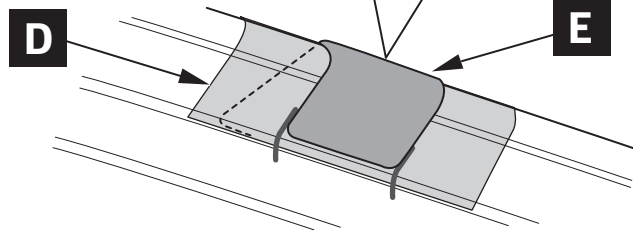
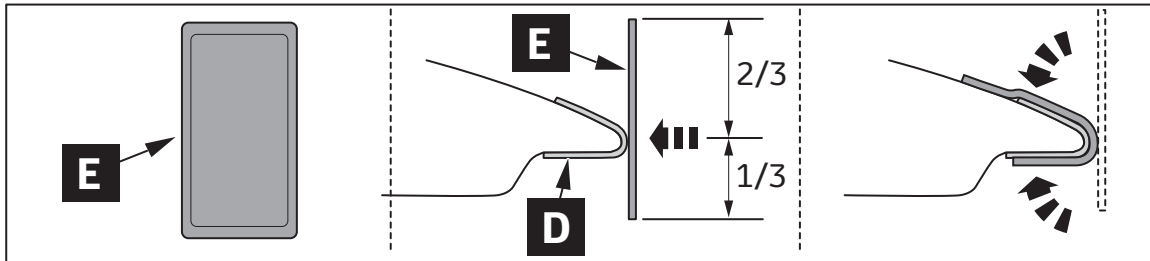

7

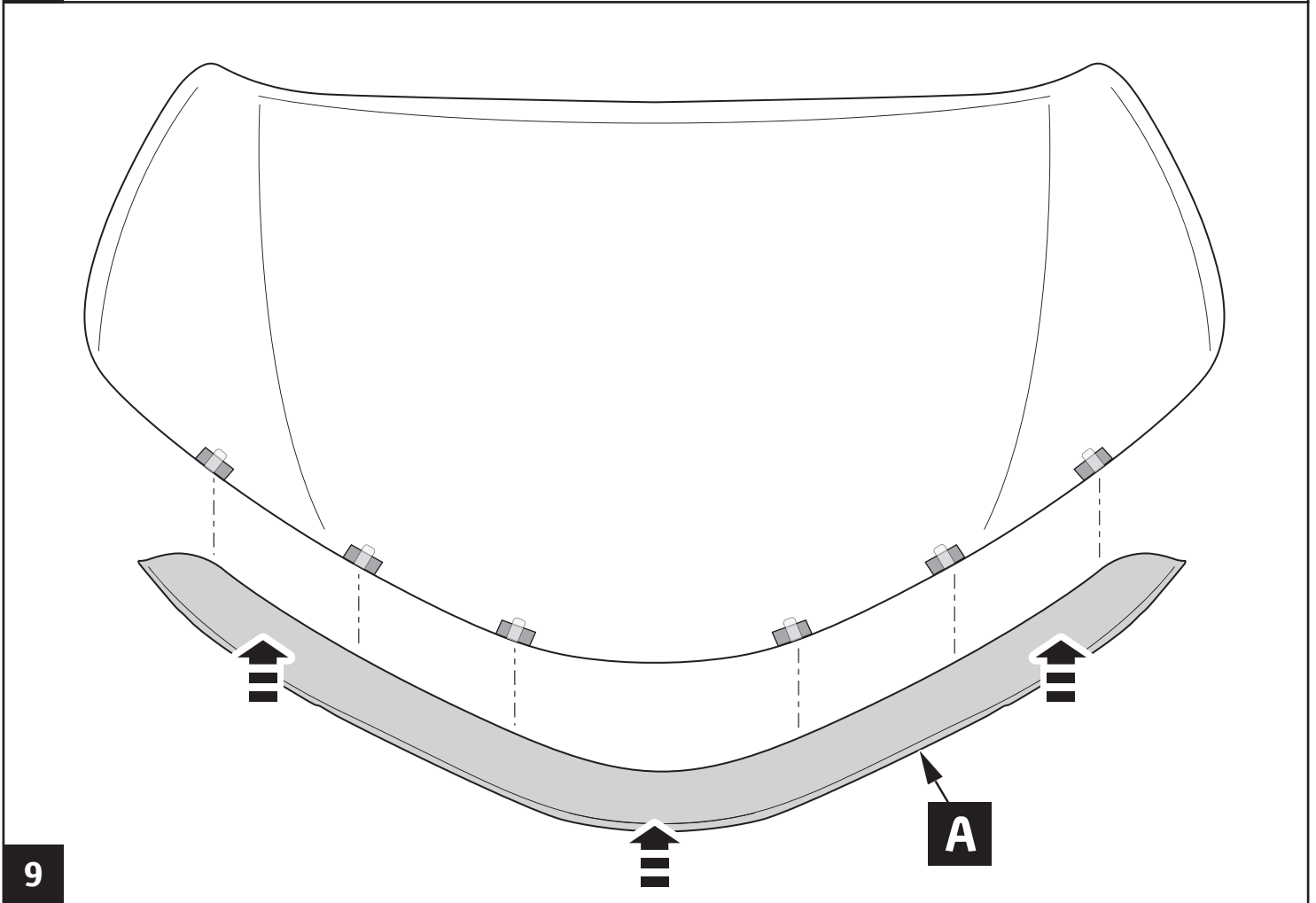
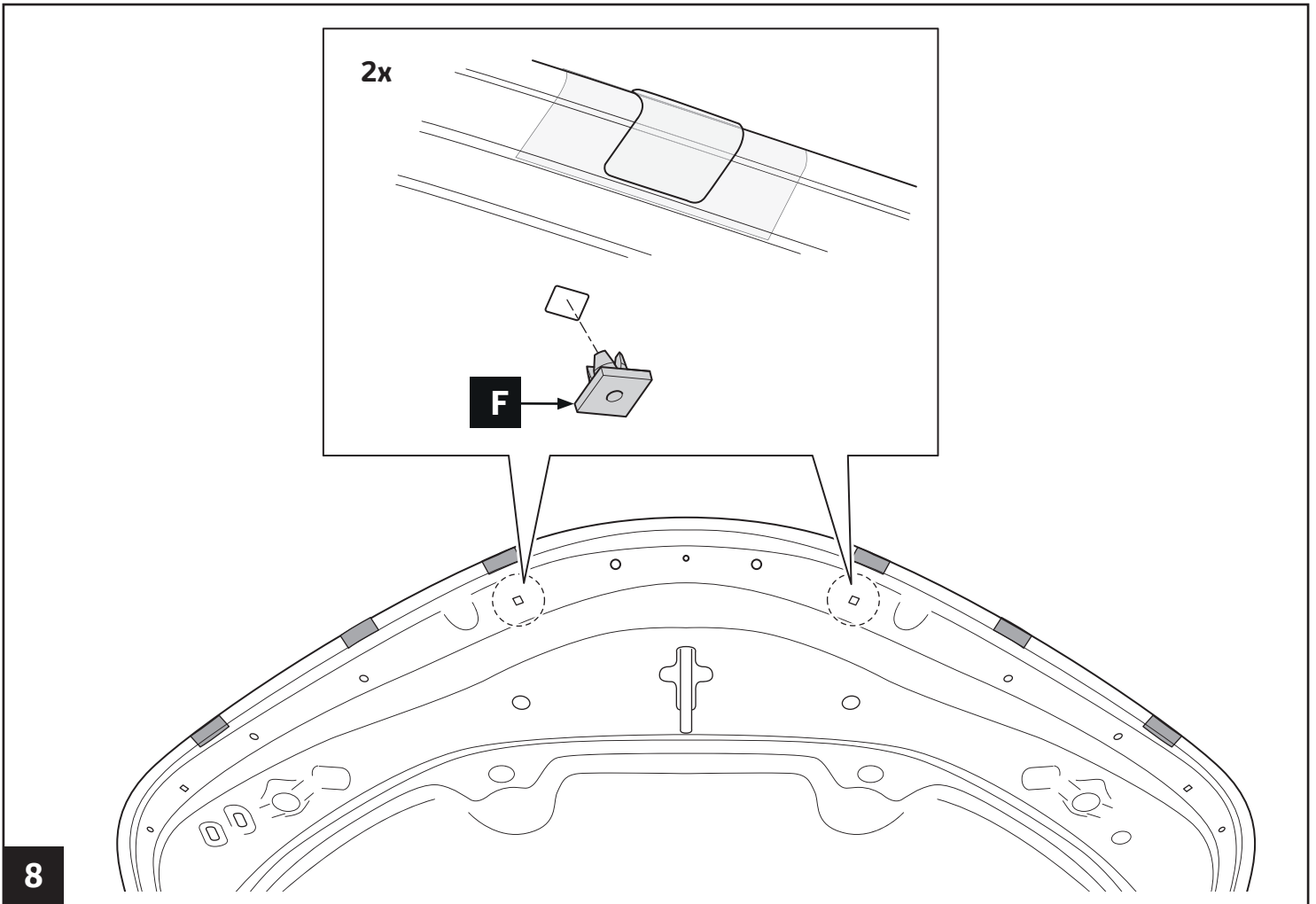



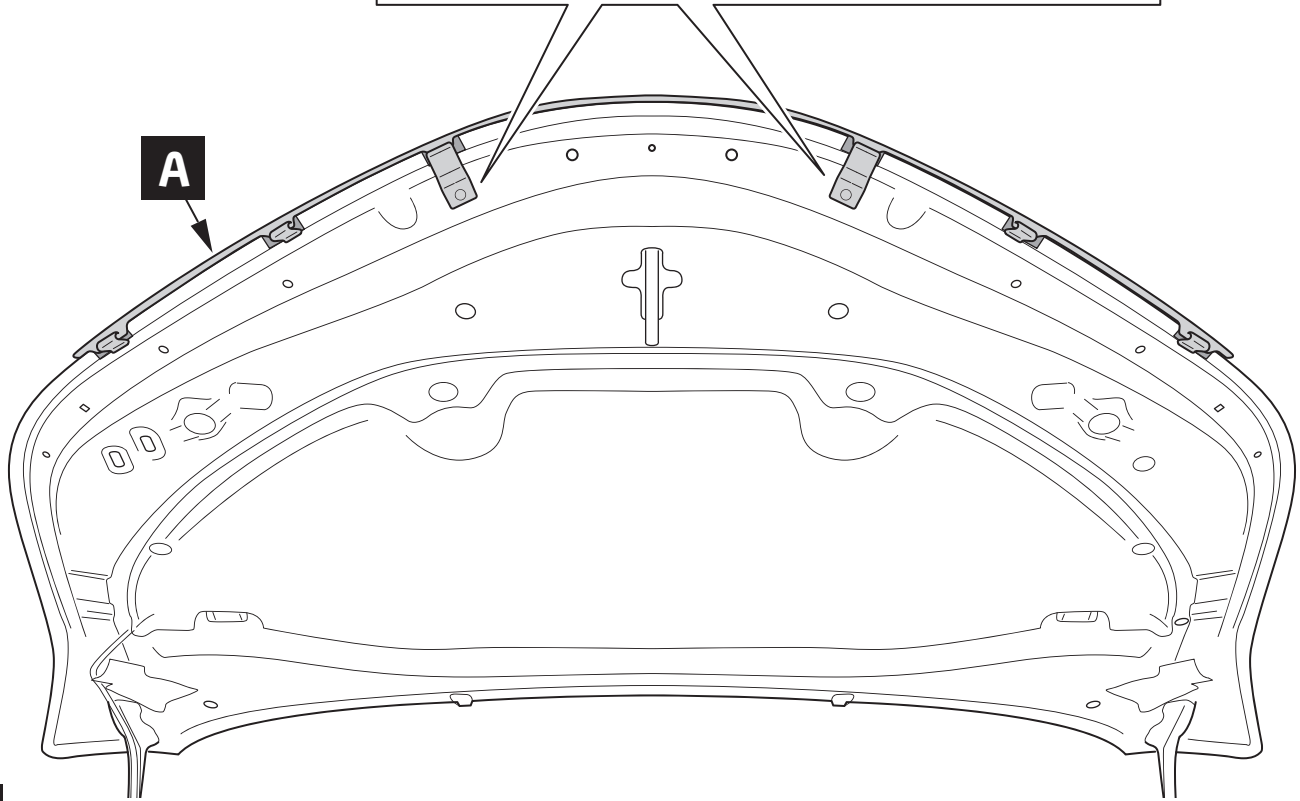
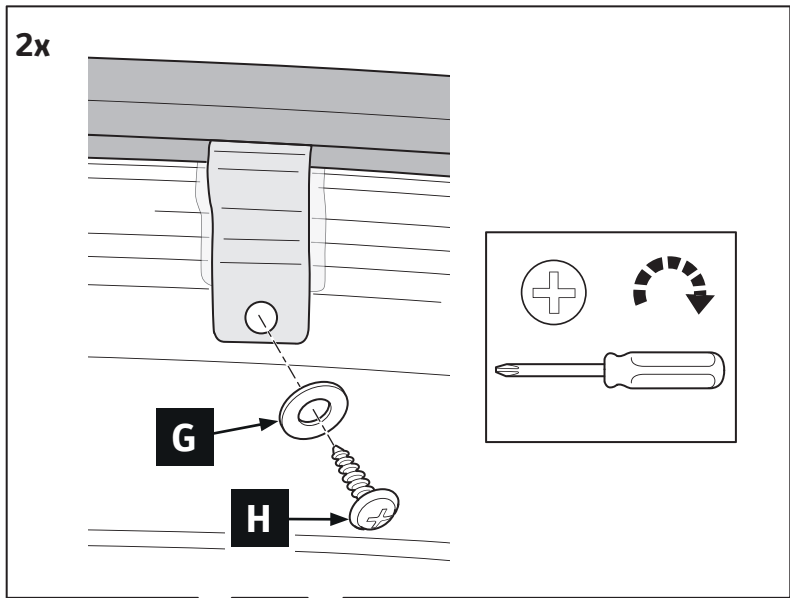

10

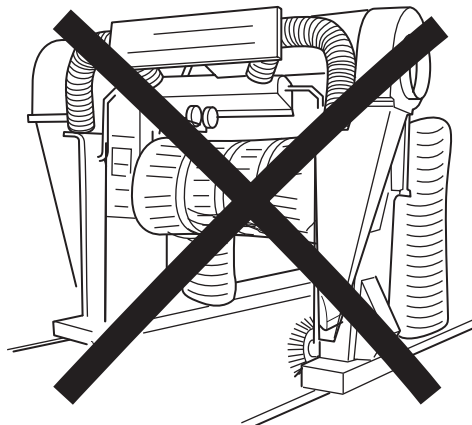

# CHECK SHEET



**TOYOTA**

Model / Year

Toyota C-HR  
2016/10, 2019/10

Hood Protector

VIN n°

ALWAYS A  
BETTER WAY

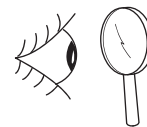
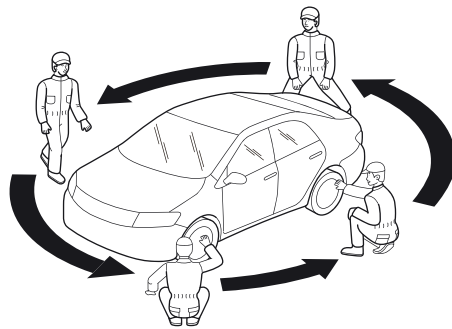
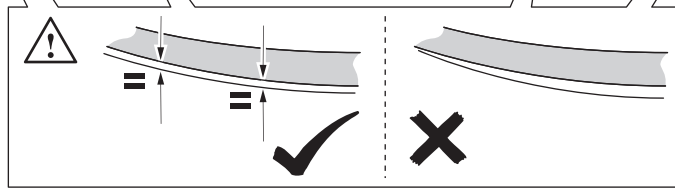
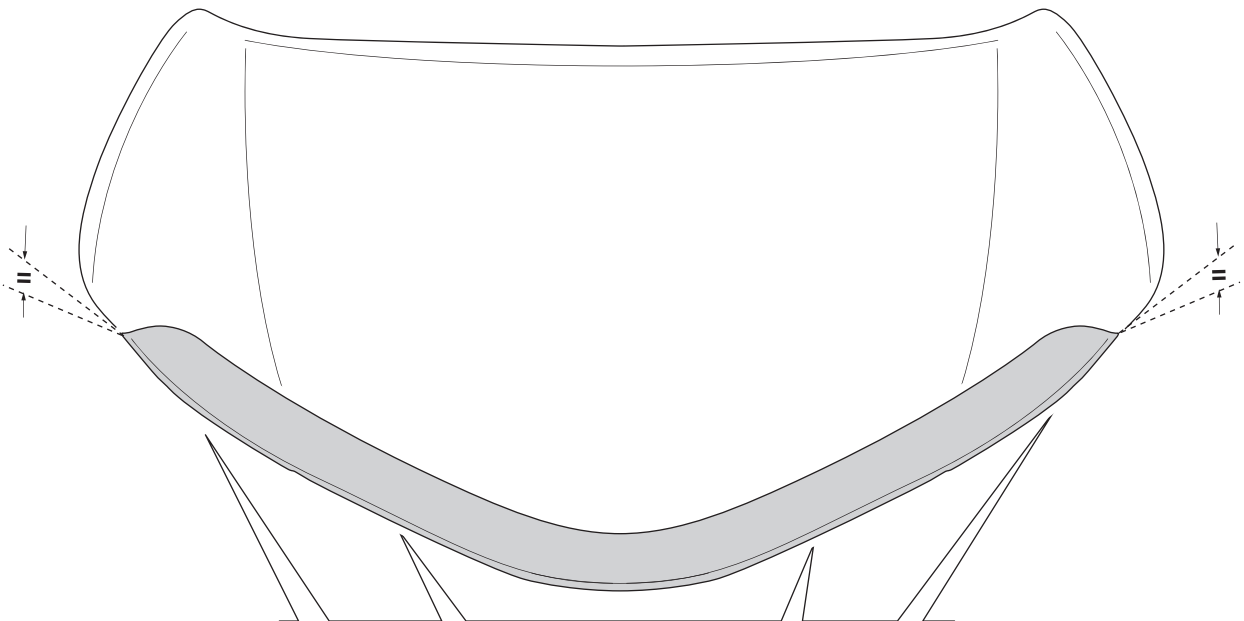
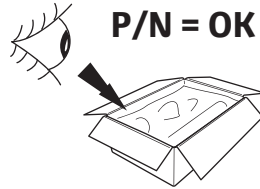

= OK

Installation Date:

. . / . . / . . . .

Technician Name & Signature:

Stamp: