

Vehicle name

Wind Deflectors - Full Kit

Installation Instructions

Model year: As from 2015/06

Vehicle code: GUN1***-D***HW
GUN1***-D***XW

Part number: PC162-0K003

Manual reference number: AIM 003 603 - 2



Revision Record

Rev. No.	Date	Page	Step	Remarks
1	09.03.20	1		Model year updated & vehicle code added
1	09.03.20	2		Kit & tools updated
1	09.03.20	3-10	1-5, 8-14	Info & steps updated
1	09.03.20	5, 6, 9	6, 7, 15	Steps added
1	09.03.20	15	C/S	Check Sheet updated
2	23.08.23	All		Updated to latest standards

KIT CONTENT

PC162-0K003

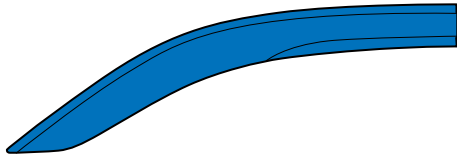

A PC162-0K00B

1x

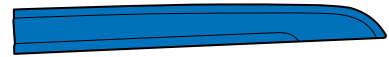

B PC162-0K00D

1x

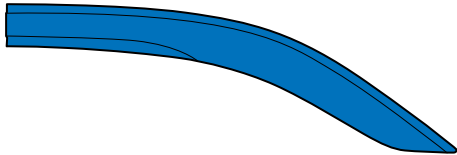

C PC162-0K00A

1x



D PC162-0K00C

1x



E PC162-0K00G

8x

TOOLS

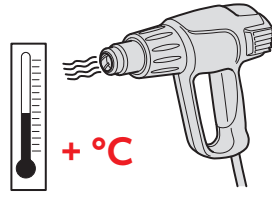
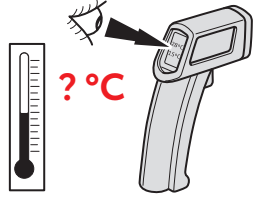
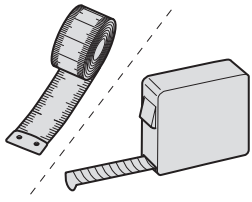

CONSUMABLES

CLEANER / DEGREASER SPRAY



MASKING TAPE



ADHESION PROMOTER



PZ415-00000-00

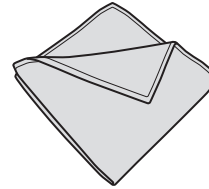

PERSONAL PROTECTION EQUIPMENT

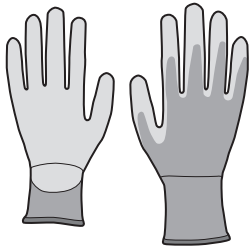

USEFUL GENERAL MANUALS

CLEANER / DEGREASER

Latest Version
SCAN HERE

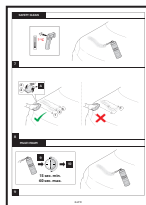

SYMBOLS

Latest Version
SCAN HERE



GENERAL



Material Safety Data Sheet



Technical Data Sheet

GENERAL

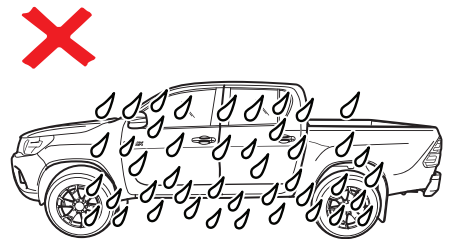
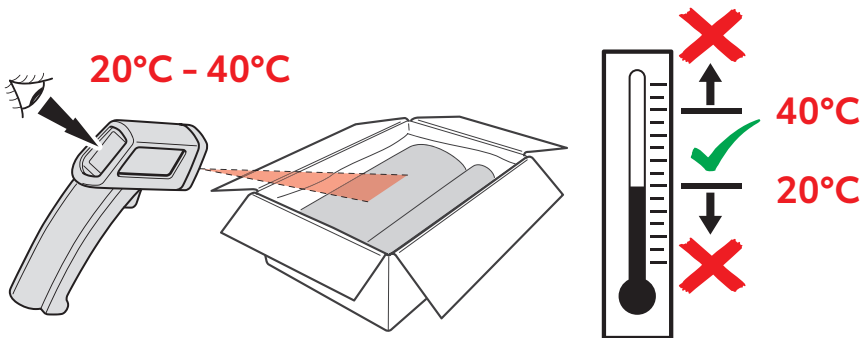
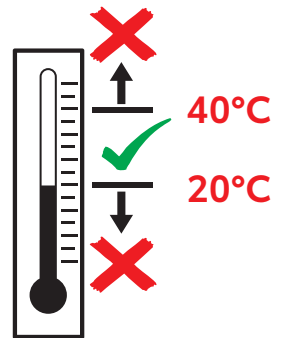
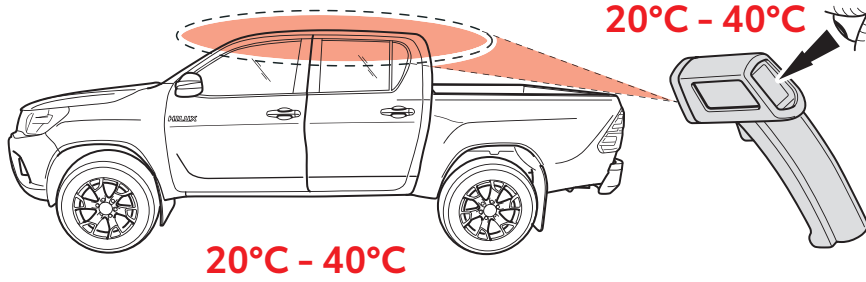

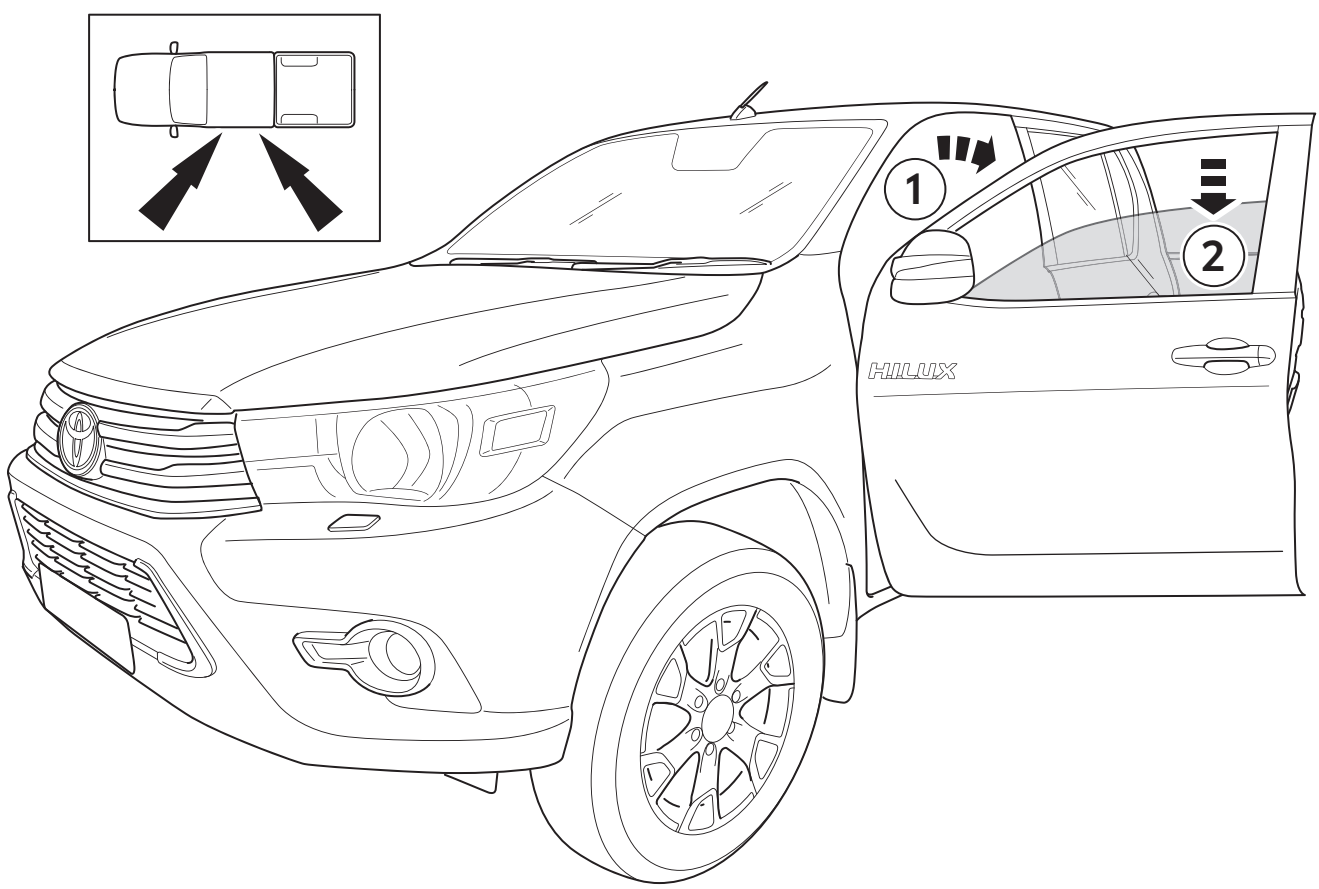

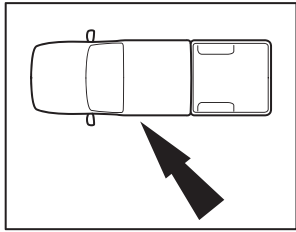

CLEANER / DEGREASER SPRAY

2

A SAFETY CLEAN 1

B MULTI FOAM 2

X

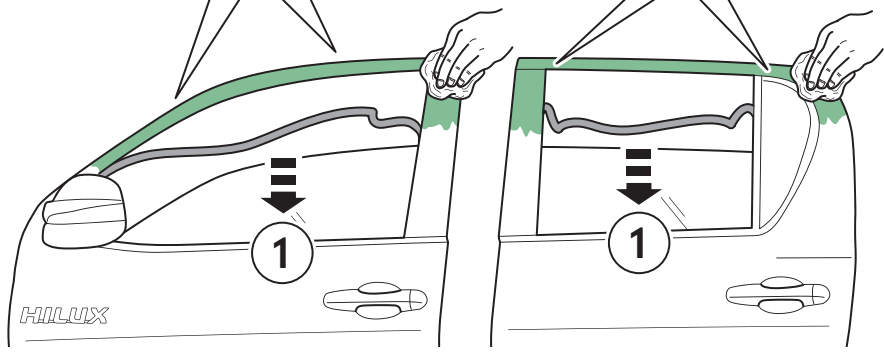

2

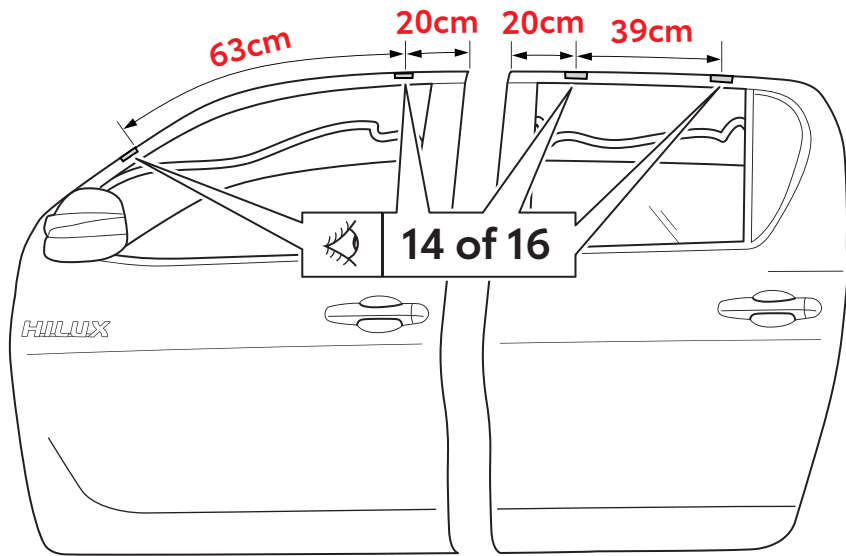
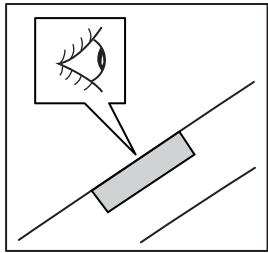
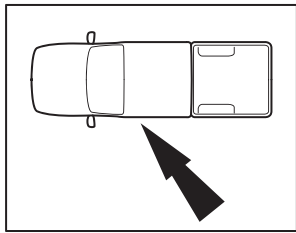

3

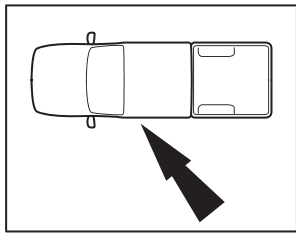

ADHESION PROMOTER

2

ADHESION PROMOTER

PZ415-00000-00

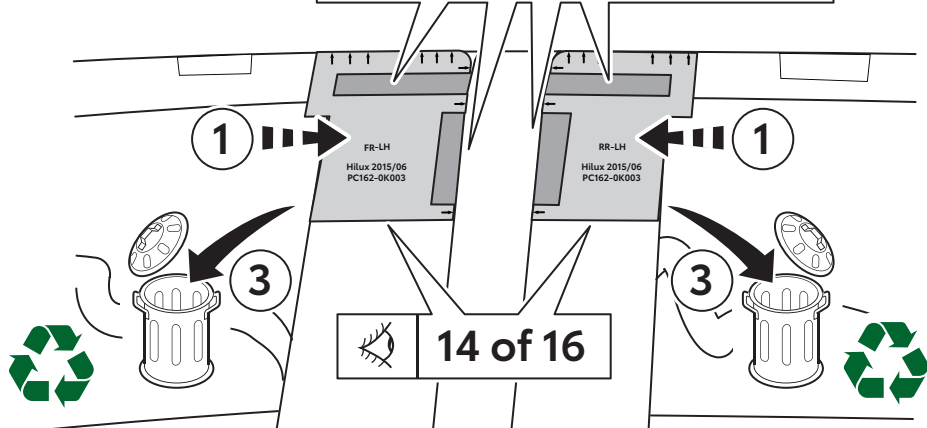

4

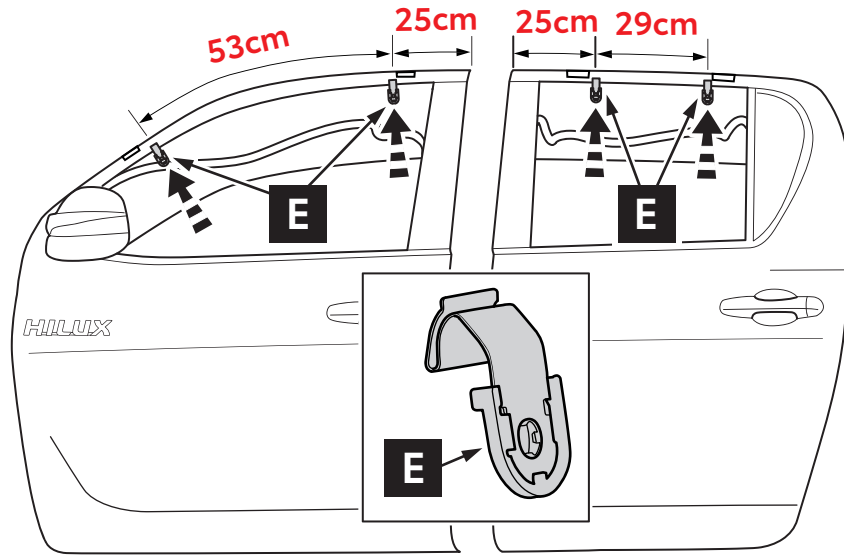
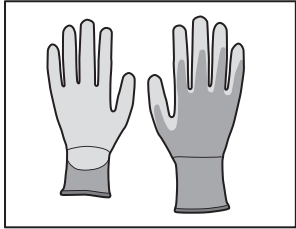
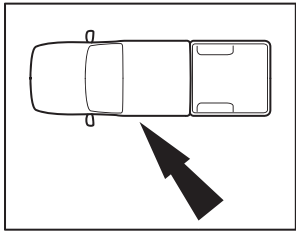

5

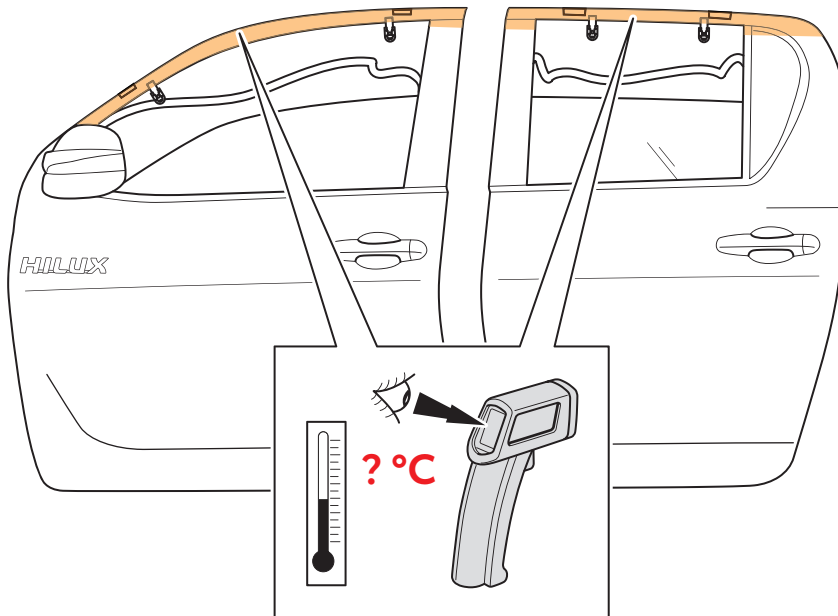

6

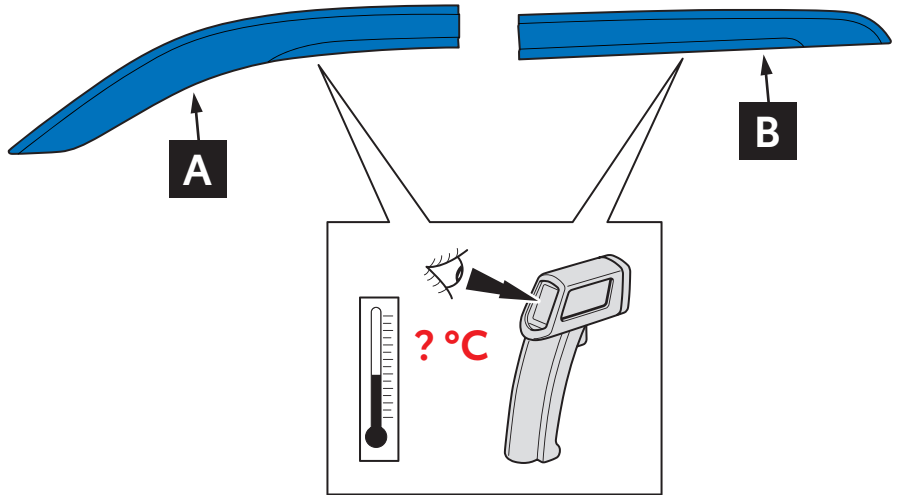

7

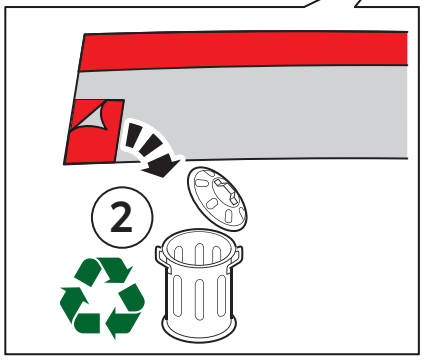
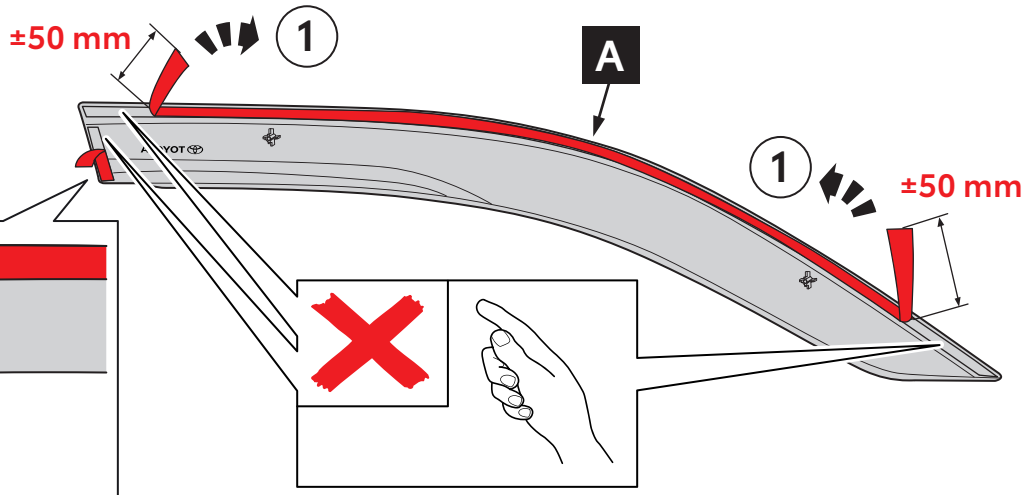
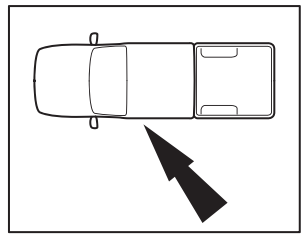

8

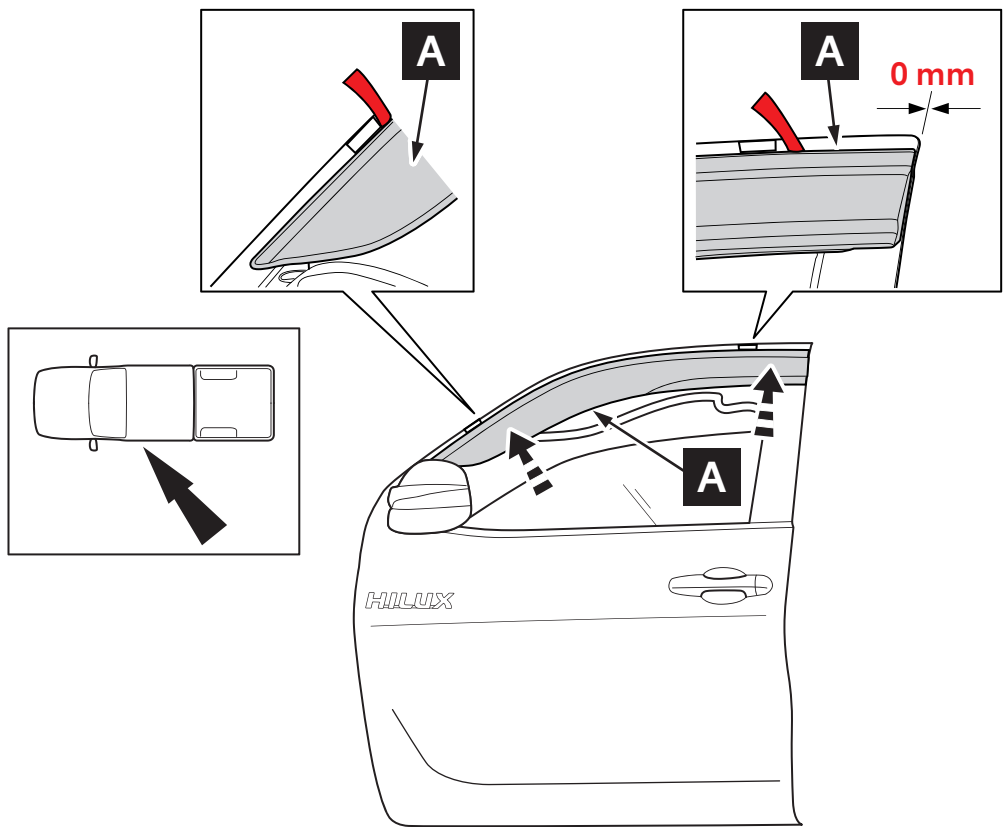

9

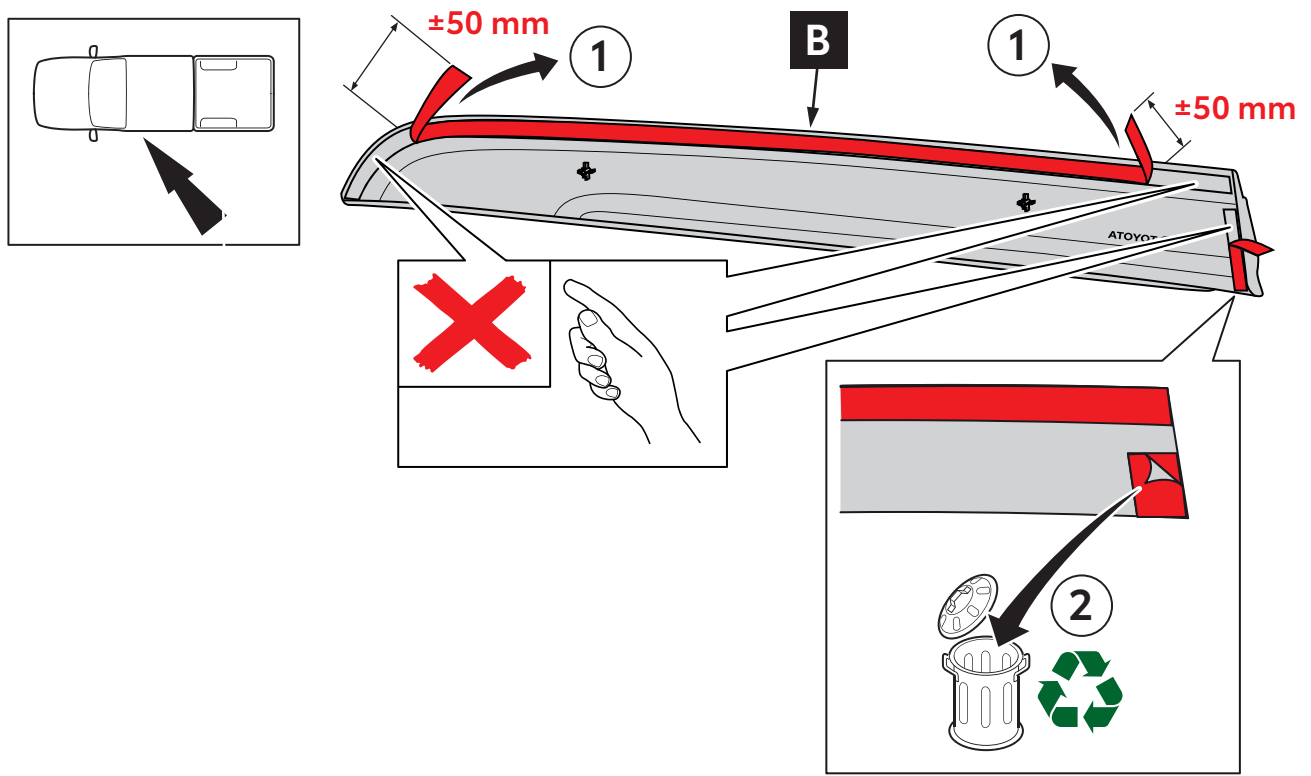

10

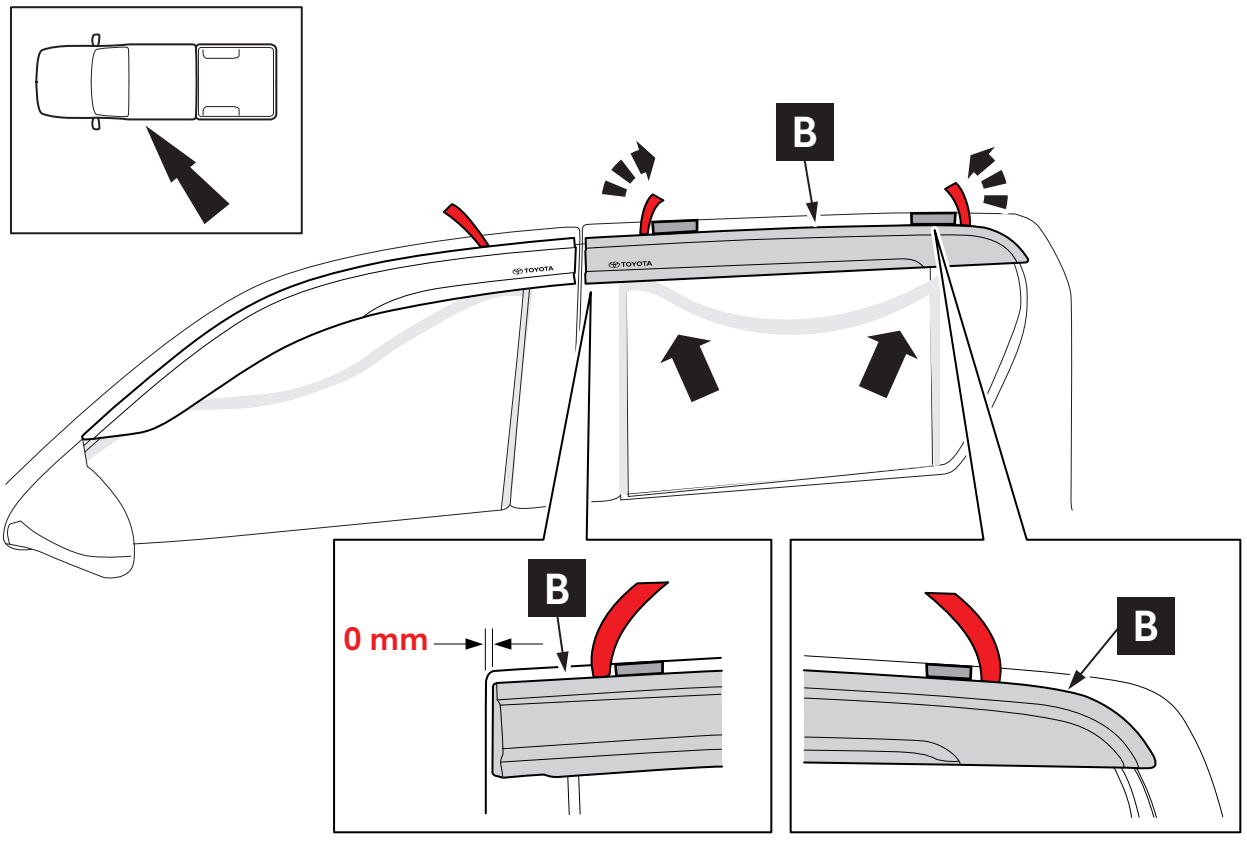

11

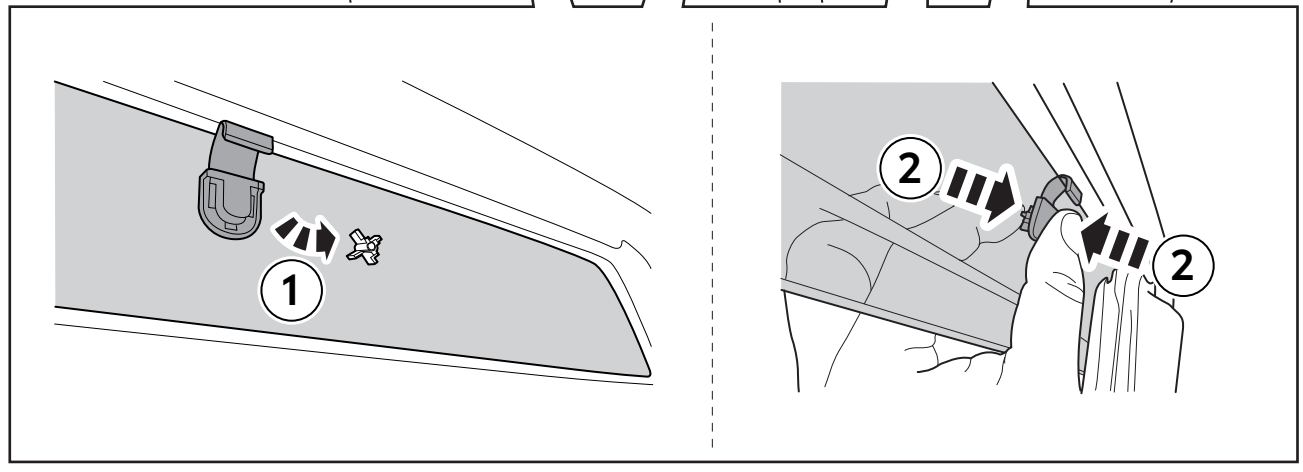
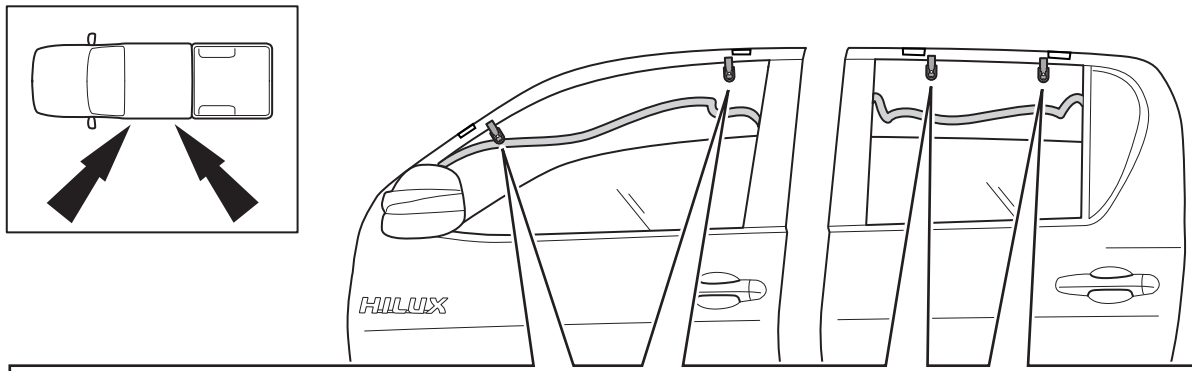

12

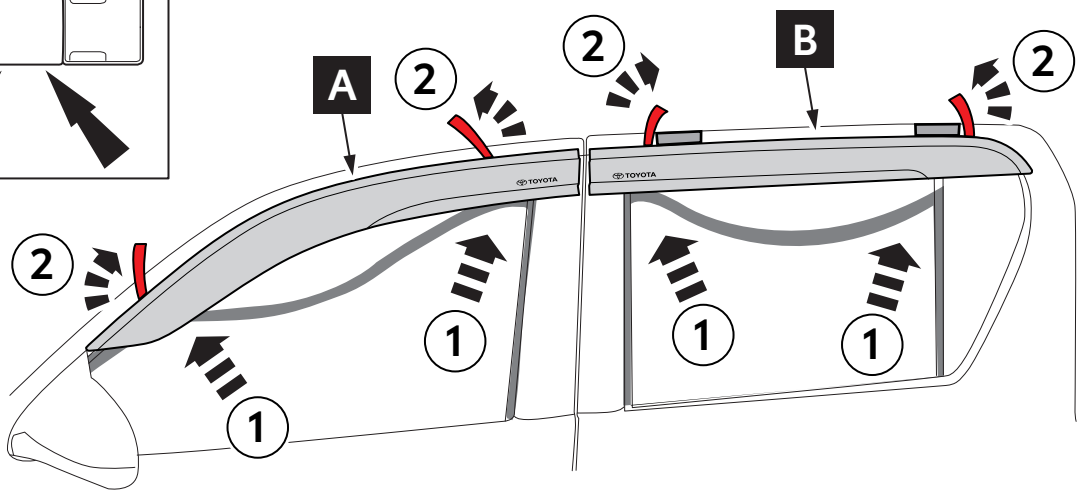
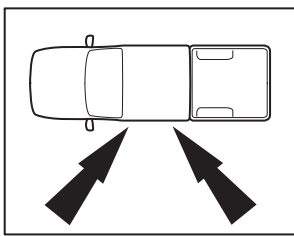

13

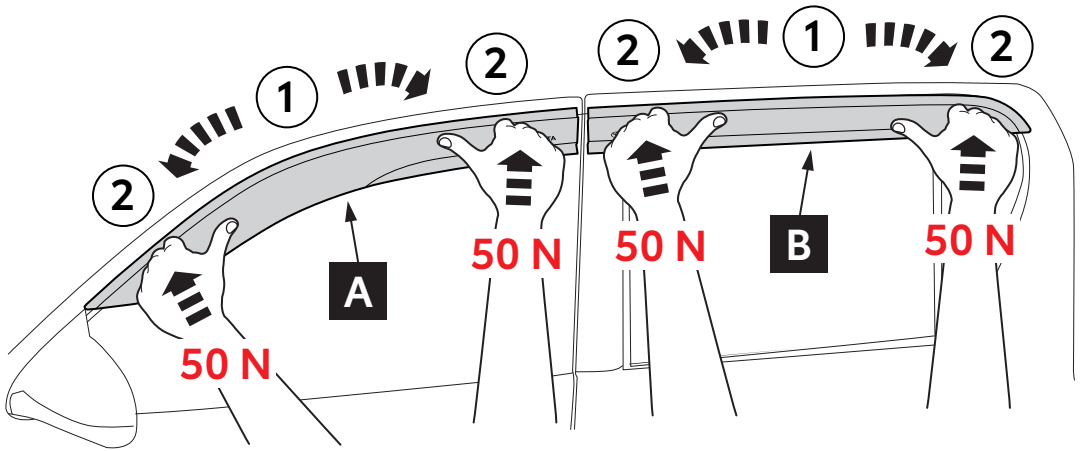
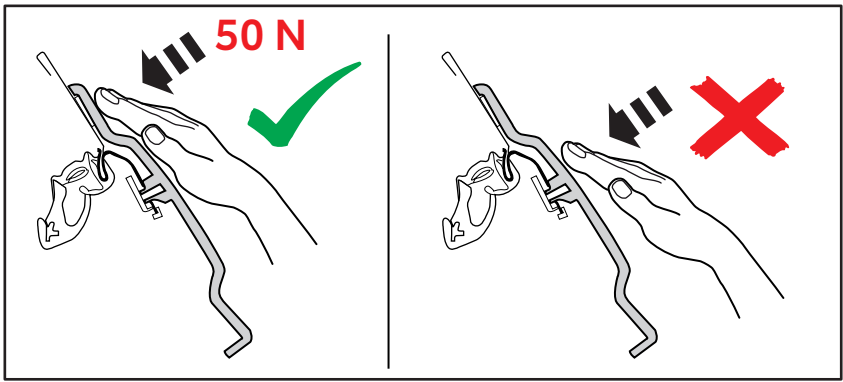
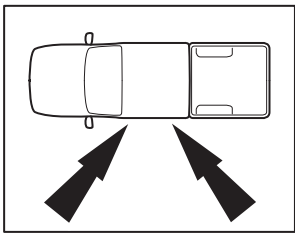

14

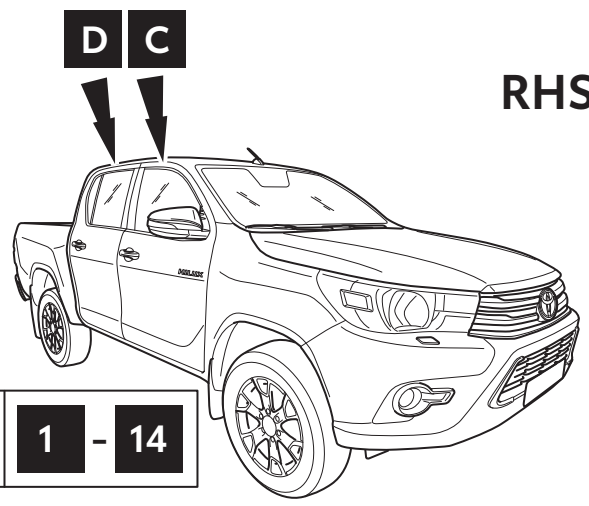

RHS = LHS

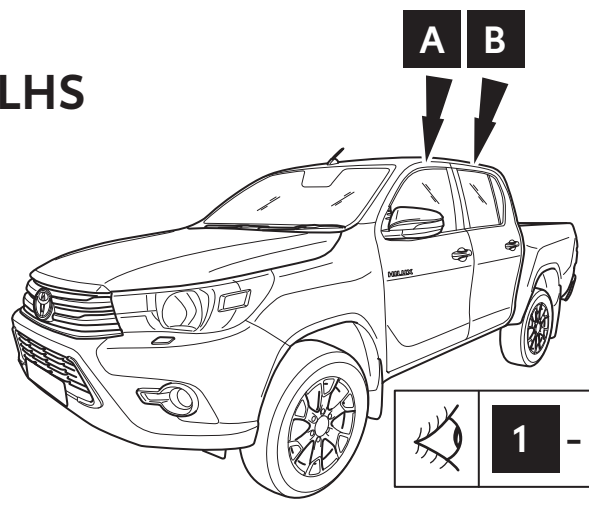

15

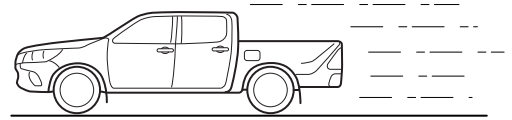
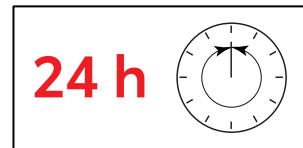
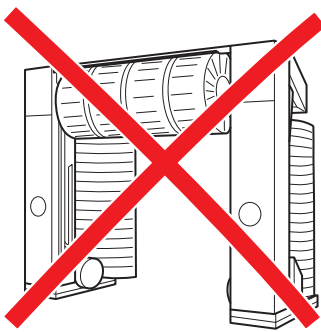
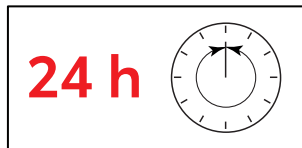
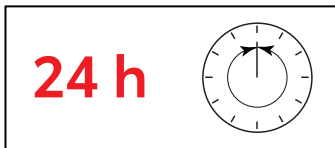

Max. 90 Km/h

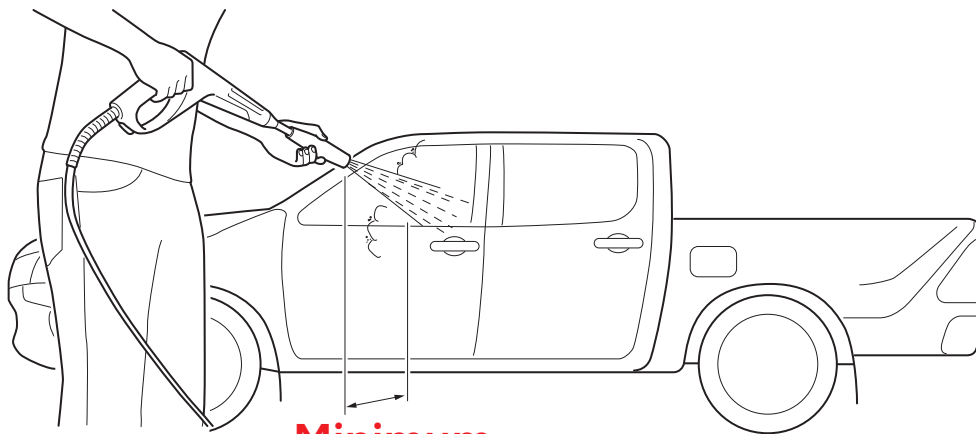

**Minimum
50cm.**

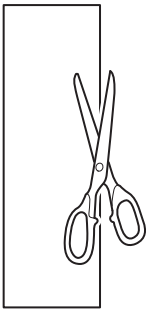
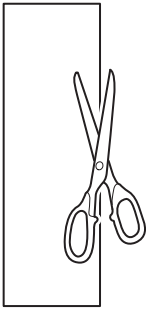
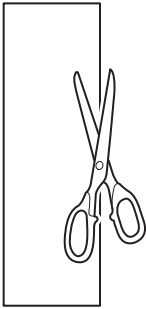
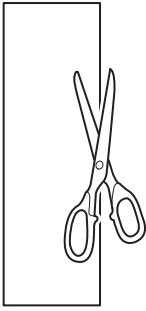
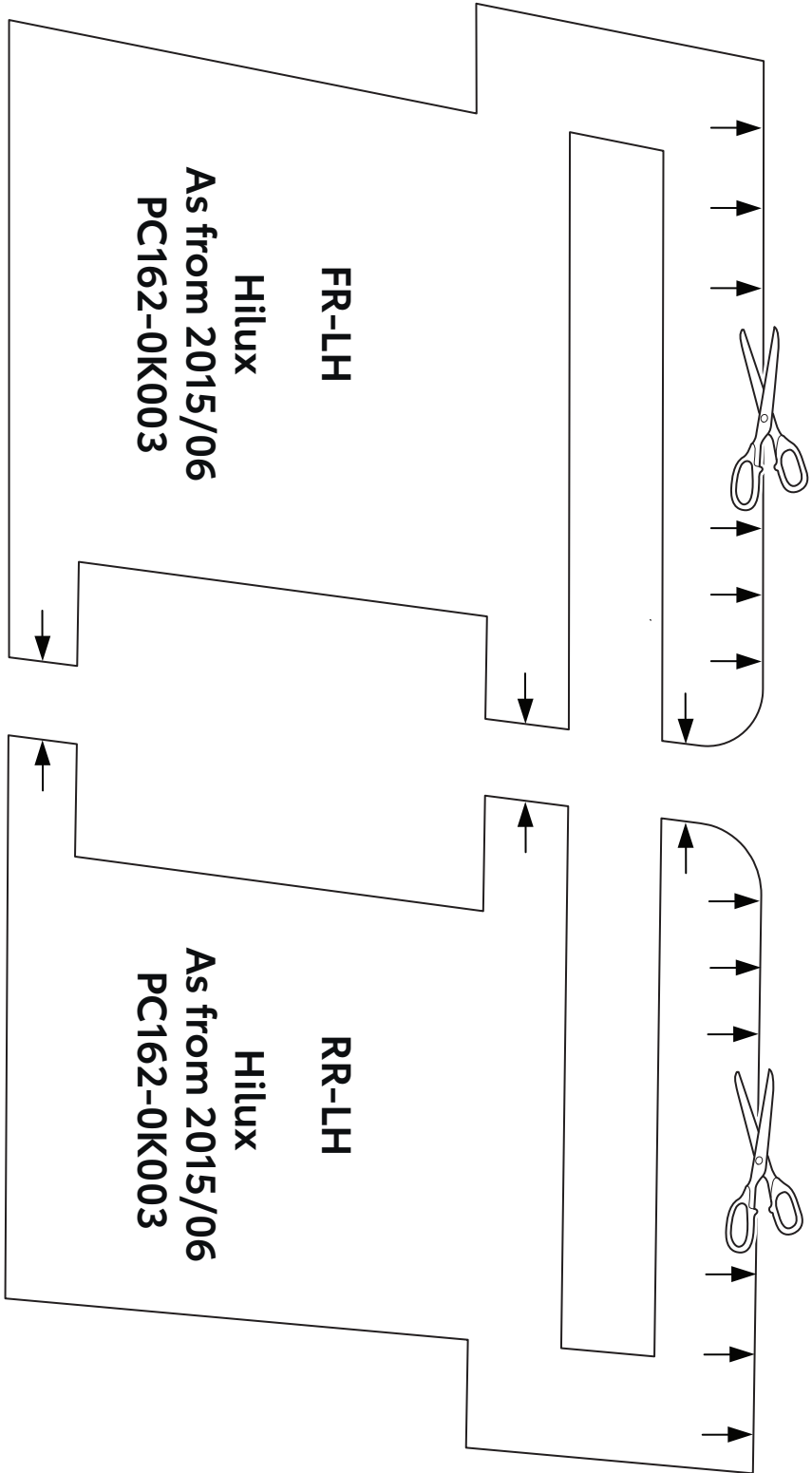
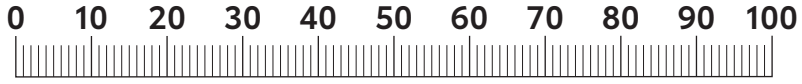

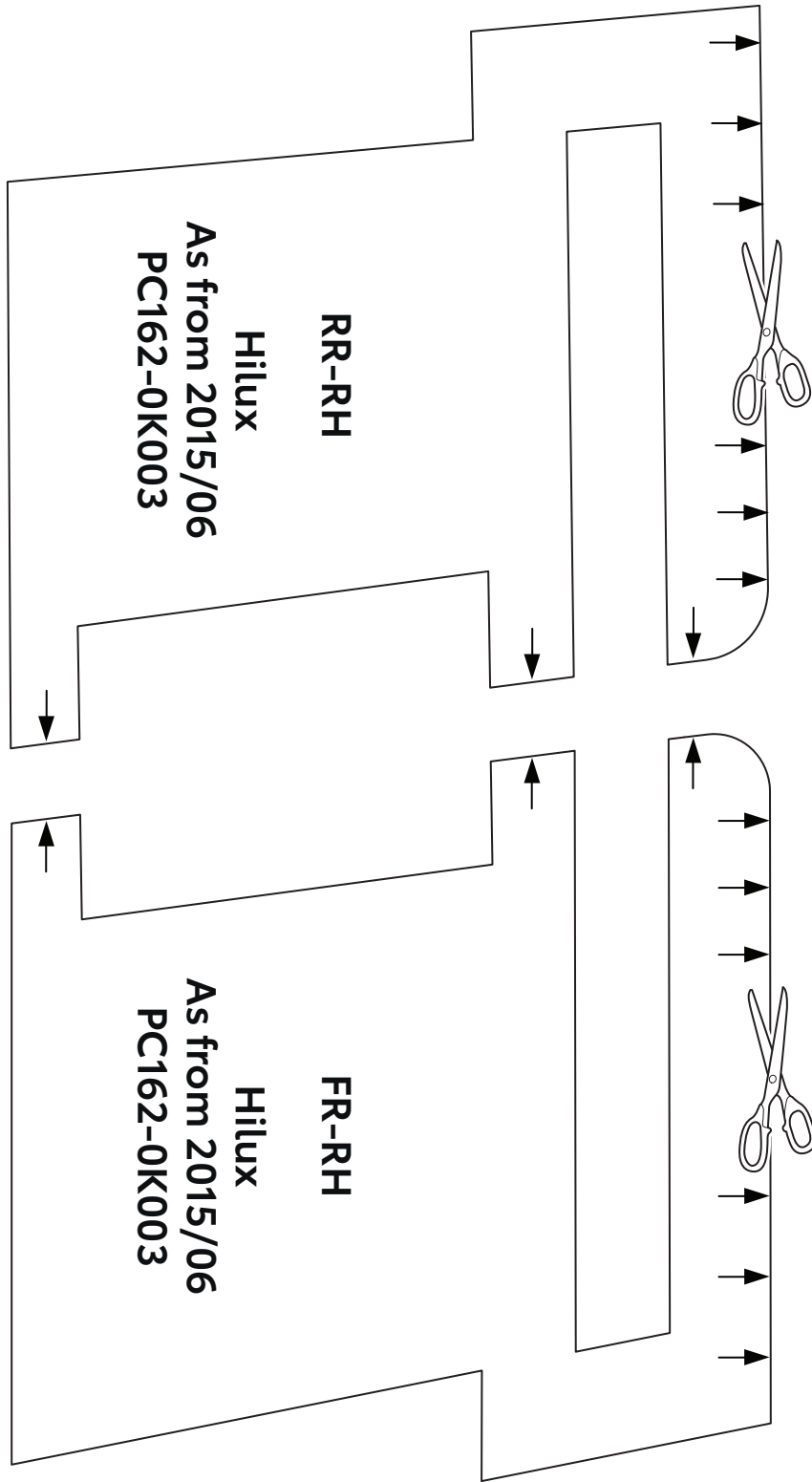

CHECK

Print 100%
Check with Rulers
before use.

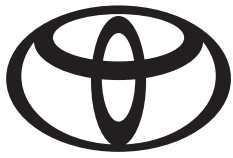

CHECK

Print 100%
Check with Rulers
before use.



CHECK SHEET

Page 1 of 1

Model/Year Hilux
As from 2015/06

Wind Deflectors - Full Kit

VINn°

DURING INSTALLATION

1

= OK
P/N = OK

AFTER INSTALLATION

1

2

3

= OK

Installation Date:

.. / .. /

Technician Name & Signature:

Stamp: